

- 01 宣传单/Flyer
- 02 折页/Broucher
- 03 海报/Poster
- 04 工艺单张/Loose Sheet With Finishing
- 05 菜单/餐垫纸/Menu/Placemat paper
- 06 爆炸签/价格签/Explosive tag/Price tag
- 07 奖状/证书/Certificate
- 08 防水菜单/Waterproof menu
- 09 门挂牌/Door hanger
- 10 门票/Ticket
- 11 创意纸雕/Creative Paper Cut Art Printing
- 12 撕拉片拍立得
Tear Off Polaroid Photo Card Printing
- 13 扑克牌/Poker cards
- 14 名片/Business card
- 15 卡片/Card
- 16 动漫卡/Anime card
- 17 刮刮卡/Scratch card
- 18 定制插卡/Customized insert card
- 19 吊牌/书签/Hangtag/Bookmark
- 20 酒挂卡/瓶挂卡/Bottle hanger card
- 21 异形卡/Custom Shape Card
- 22 卡头/Header Card
- 23 PVC名片/PVC business card
- 24 PVC会员卡/PVC membership card
- 25 PVC数码工艺卡/PVC Digital Printing Card
- 26 PVC异形卡/PVC Custom Shape Card

- 27 PVC证件卡/PVC ID card
- 28 PVC半透卡/Frosted Card
- 29 PVC刮刮卡/PVC scratch card
- 30 不干胶-贴画/Sticker
- 31 纸箱标签/Carton label
- 32 封口签/Sealing label
- 33 打印标签/Printing label
- 34 户外宣传贴/Outdoor poster
- 35 工艺标签/Label With Finishing
- 36 精装画册/HardCover Booklet
- 37 骑马钉画册/Saddle Stitch Booklet
- 38 胶装画册/Perfect Binding Booklet
- 39 合同说明书/Contract Instruction Manual
- 40 笔记本/Notebook
- 41 封套/Cover sleeve
- 42 精品卡套/房卡套
Boutique card holder/Key card holder
- 43 筷子套/Chopsticks sleeve
- 44 信封/Envelopes
- 45 档案袋/Document Folder
- 46 档案盒/凭证盒/File box/Voucher box
- 47 手写联单/Bill Book
- 48 机打联单/Computer Form
- 49 票本/Ticket Book
- 50 热敏收银纸/Thermal receipt paper
- 51 便利贴/Sticky Notes
- 52 书砖/Book Brick
- 53 红头文件/Document with red headline

- 54 喷绘/Large Format Printing
- 55 写真/Large Format Printing (High Quality)
- 56 UV彩白彩/UV color-white-color print
- 57 UV单喷/双面喷/UV Single Side Printing/
UV Double Side Printing
- 58 UV磁吸贴/Magnet with Sticker UV Printing
- 59 UV磁吸画/UV Coated Magnetic Wall Art
- 60 展架/展板/Display rack/Display board
- 61 灯箱画面/Light box image
- 62 灯箱(整套)/Light box (complete set)
- 63 旗帜/Flag
- 64 条幅/Scroll
- 65 手拉旗/Handheld Pull-Up Flag
- 66 锦旗绶带/Silk Banner and ribbon
- 67 门帘/桌旗/手摇旗
Door Curtain/Table Flag/Hand Waving Flag
- 68 水晶标/Crystal label
- 69 金属标/Metal label
- 70 钛金牌/Titanium medal
- 71 金属徽章/Metal Badge
- 72 吧唧徽章/Badge
- 73 亚克力周边/Acrylic Peripherals Products
- 74 授权奖牌/Authorization medal
- 75 发光字/Luminous character
- 76 雕刻字/Engraved Character
- 77 PVC雪弗板/Foamed PVC sheet
- 78 白卡纸袋/礼品袋/ArtCard Paper Bag/
Gift Bag

- 79 环保纸袋/Eco-friendly paper bag
- 80 帆布袋/Canvas bag
- 81 毛毡袋/Felt bag
- 82 PP料透明袋/PP material transparent bag
- 83 复合揉纹袋/Composite Textured Bag
- 84 抱枕/Cushion
- 85 彩色淋膜袋/无纺布丝印袋/Color film laminated bag/Nonwoven silk-screen printing bag
- 86 纸抽/Tissue box
- 87 纸杯/Paper cup
- 88 纸碗/Paper bowl
- 89 杯垫/Coaster
- 90 腰封/Belly band
- 91 白卡纸盒/ArtCard Box
- 92 精装盒/Hardcover box
- 93 蛋糕盒/Cake box
- 94 透明盒/Transparent Box
- 95 鼠标垫/Mouse pad
- 96 桌垫/地垫/Table mat/Floor mat
- 97 框画/摆台/Grade Framed Artwork/Grade
Tabletop Display
- 98 折叠投影灯/Foldable Projection Light
- 99 梅妃竹产品/Meifei Bamboo Products
- 100 广告扇/Advertising Fan
- 101 台历挂历/Desk calendars and wall calendars
- 102 年货/Festival items
- 103 供应链/Supply chain
- 104 碳粉硒鼓墨盒/Toner Cartridge

Part 01

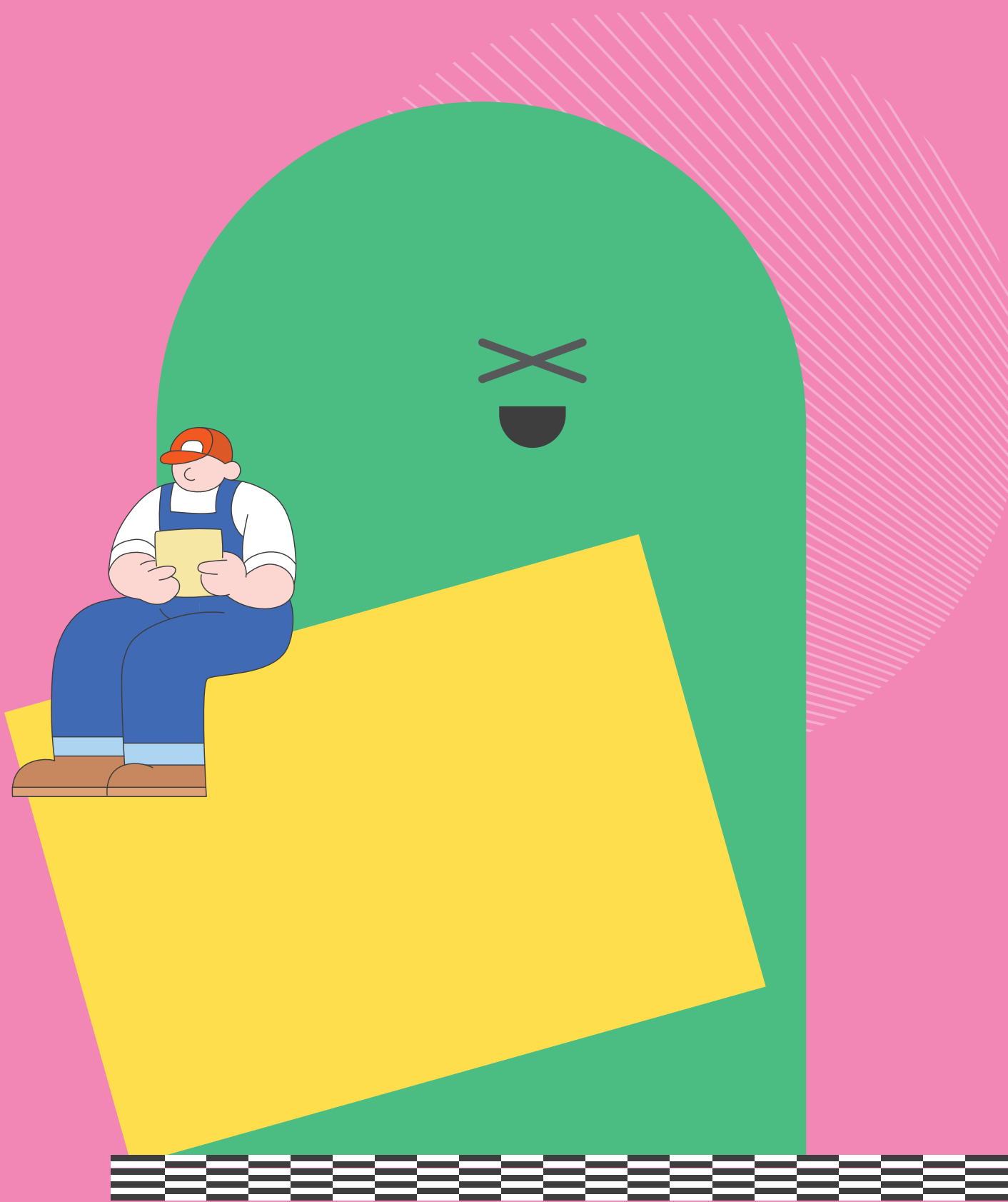

ShengDa Print Malaysia,
No.6, Persiaran Industri, SD5, Bandar Sri Damansara,
52200 Kuala Lumpur, Malaysia.
+6011 1071 2377

PRODUCT MANUAL 2026 产品手册

宣传单/Flyer 01



02 折页/Broucher

A 常规折页 Conventional foldout

主要有对折、包心折、风琴折、关门折、十字折、宝塔折等

使用场景: 企业产品宣传、菜单、邀请函、录取通知书、售后卡等

Mainly there are Half-Fold, Tri-Fold, Z-Fold, Double Gate Fold, French Fold, etc.
Application scenarios: enterprise product promotion, menus, invitations, admission notices, after-sales cards, etc.

一折二页

One fold and two pages



对折
Half-Fold



不对称折
Uneven Fold

二折三页

Two folds and three pages



风琴折
Z-Fold(3-Panel Accordion Fold)



包心折
Tri-Fold(3-Panel Roll Fold)

三折四页

Three folds and four pages



风琴四折
4-Panel Accordion Fold

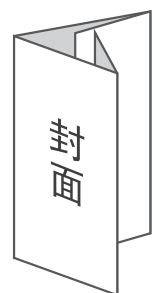

关门折
Double Gate Fold

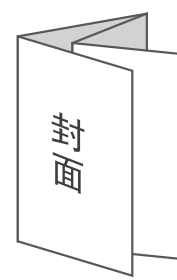

对折再对折
Double Parallel Fold

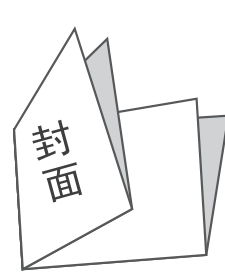

十字折
French Fold(Quarter Fold)



B 混合折页 Mixed foldout

常用折法有：

风琴三折再对折、风琴四折再对折、风琴四折再风琴四折、包心三折再包心三折等，更多新型折法等您来解锁。

适用材质：157克及以内的薄纸，新增120克新美感高白，折页效果更佳。

使用场景：说明书、旅游地图、思维导图、博物馆展品说明等

Common folding methods include:

All kinds of customized folding methods are waiting for you to unlock.

Applicable materials: Thin paper weighing 157g or less, new 120g premium paper added, providing a better folding effect.

Usage scenarios: Instruction manuals, tourist maps, mind maps, museum exhibit descriptions, etc.

Multiple Folded



C 异形折页 Irregular foldout

形状不限, 创意无限。

适用材质: 157克及以上的厚纸

工艺搭配: 模切(必选)、烫金、UV、击凸、压纹、过油等

使用场景: 菜单、通知书、信封、工艺品展示、创意折卡等

The shape is unrestricted, and creativity knows no bounds

Applicable materials: Thick paper of 157g and above
Process combination: Die-cutting (mandatory), hot stamping, UV coating, embossing, varnishing, etc.

Usage scenarios: menus, notices, envelopes, craft displays, creative folding cards, etc.





工艺/processes

常做工艺-覆膜-烫金-烫银-击凸-压凹-UV-异形模切

Commonly used processes-laminating-gold stamping-silver stamping-embossing-debossing-UV coating-die-cutting in special shapes



异形卡片/Irregular-shaped card

异形卡片/Irregular-shaped card



烫金/Gold stamping

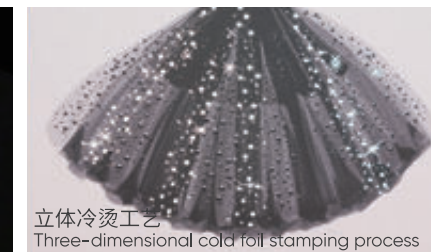

立体冷烫工艺
Three-dimensional cold foil stamping process

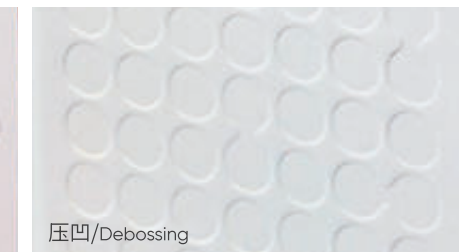

压凹/Debossing



立体UV工艺
Three-dimensional UV process



星光膜/Starlight film

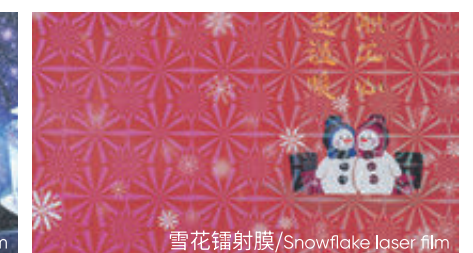

雪花镭射膜/Snowflake laser film

05 菜单/餐垫纸/Menu/Placemat paper

爆炸签/价格签/Explosive tag/Price tag 06



07 奖状/证书/Certificate



ShengDa Print Malaysia,
No.6, Persiaran Industri, SD5, Bandar Sri Damansara,
52200 Kuala Lumpur, Malaysia.
+6011 1071 2377

PRODUCT MANUAL 2026 产品手册

防水菜单/Waterproof menu 08



09 门挂牌/Door hanger



门票/Ticket 10



11 创意纸雕/Creative Paper Cut Art Printing

撕拉片拍立得/Tear Off Polaroid Photo Card Printing 12

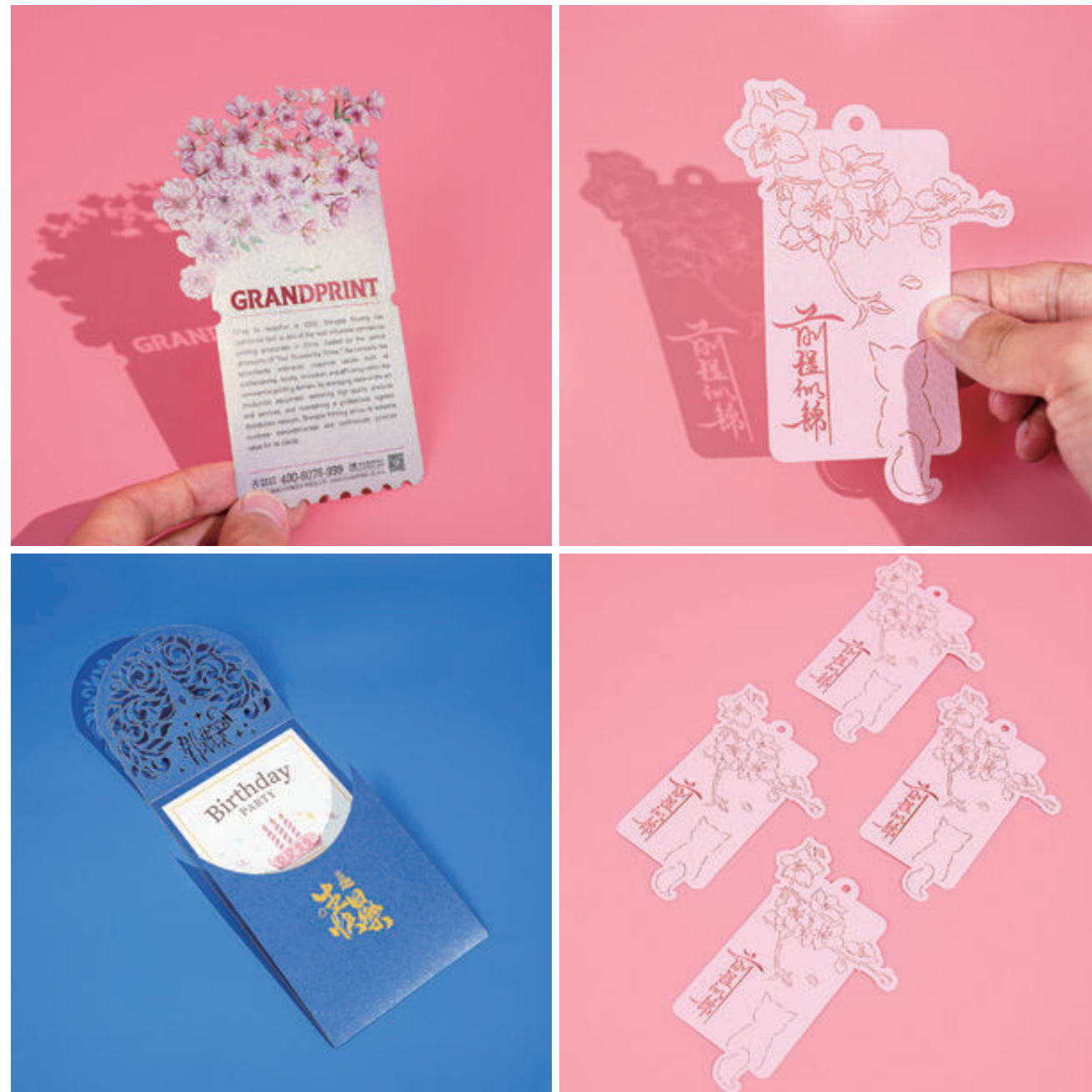

13 扑克牌/Poker cards



100副起订 牌芯、牌盒全页面定制

Minimum order quantity: 100 pairs
Full-page customization of card cores and card boxes

扑克牌分类:

常规扑克牌 57*87MM

攒蛋扑克牌 59*96MM

Classification of Playing Cards

Standard playing cards 57*87MM

Guandan Playing Cards 59*96MM

PLAYING
CARDS

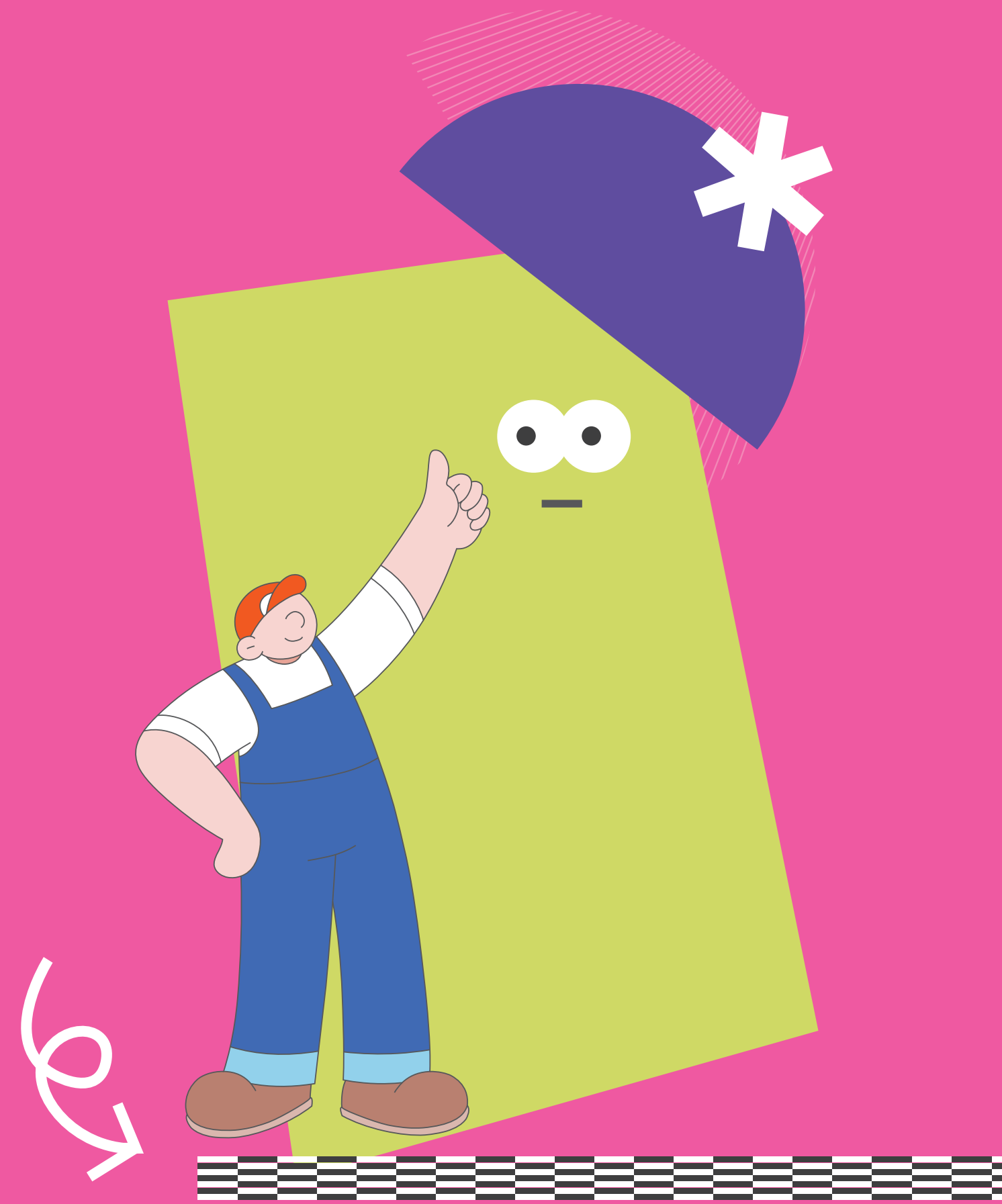

14 名片/Business card

重点为多维度(多个纹路,多种材质厚度,多工艺,多档次),满足客户需求,材料类别分为:普通、中端、高端

普通:铜版纸350克、铜版卡纸500克

可做工艺:直角、圆角、立体UV、热烫

The key points are multi-dimensionality (multiple patterns, various material thicknesses, multiple processes, and different grades), to meet customer demands.

Material categories are classified as: common, mid-range, and high-end.

Common: Art Paper 350gsm, Art Card 500gsm

Available processes: right angle, round corner, 3D UV, hot stamping

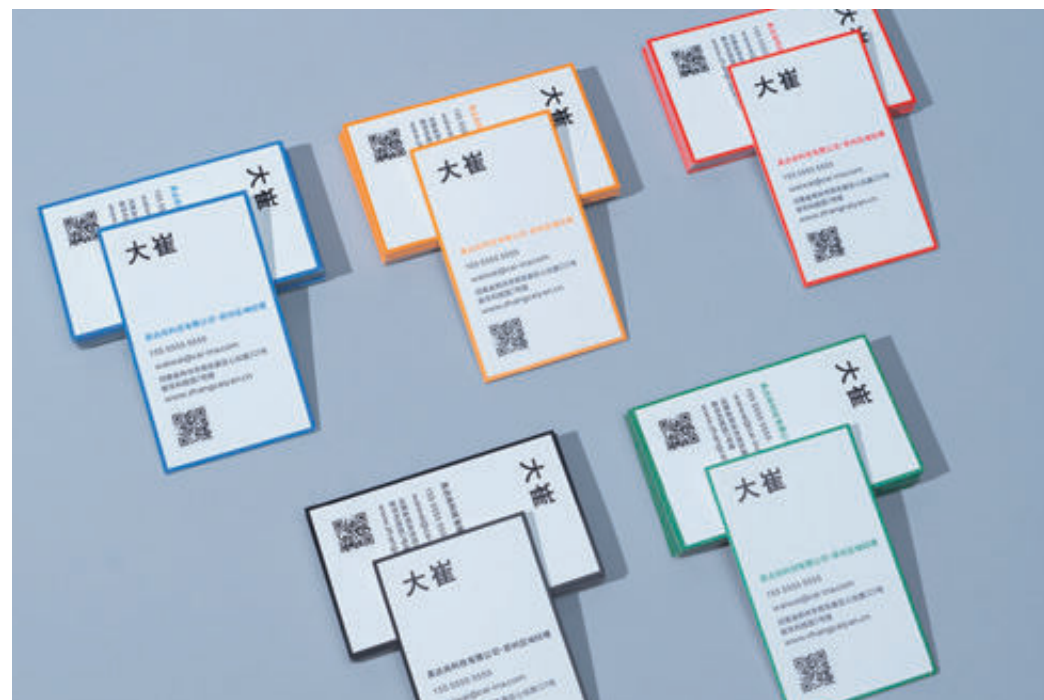

中端 350克瑞典环保白卡、350克白滑影(冰白)、350克德国经典麻纱纹超白、350克德国经典麻纱纹米黄、350克哥蒙德针孔超白、350克英国尼桑蛋壳纹、350克白唯美、700克白滑影(冰白)、700克德国经典麻纱纹超白、700克哥蒙德针孔超白、700克白唯美

可做工艺:直角、圆角、热烫

Mid-range: 350g Swedish eco-friendly white card, 350g/700g pearlescent paper, 350g/700g German classic linen texture ultra-white, 350g German classic linen texture beige, 350g/700g Gmund pinhole ultra-white, 350g British Nisin eggshell texture, 350g/700g premium paper
Available processes: right angle, round corner, hot stamping



350克白唯美/350g premium paper



350克哥蒙德针孔超白/350g Gmund pinhole ultra-White



350克英国尼桑蛋壳纹-烫蓝金
350g British Nisin eggshell texture-Blue gold stamping



350克白滑影(冰白)
350g pearlescent paper



350克瑞典环保白卡
350g Swedish eco-friendly white card



350克哥蒙德针孔超白
350g Gmund pinhole ultra-white



350克德国经典麻纱纹超白
350g German classic linen texture ultra-white



350克德国经典麻纱纹米黄
350g German classic linen texture beige

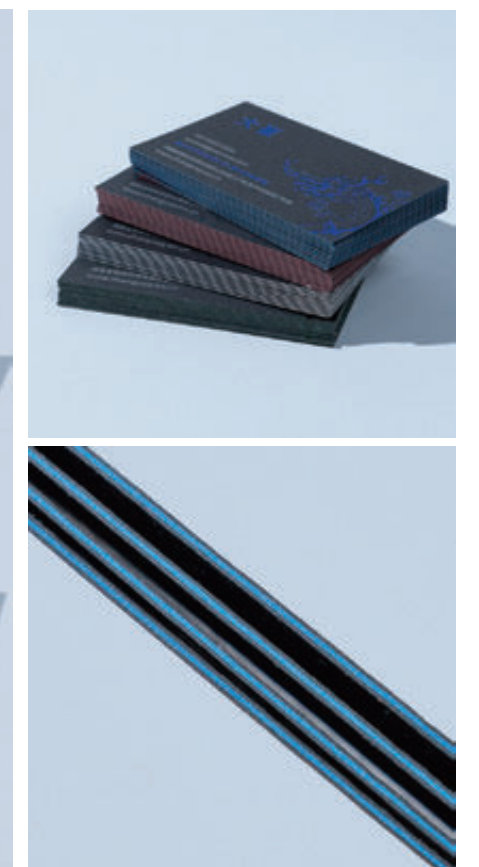

高端: 荷兰白卡480克、黑卡500克、爵士金属白金500克、威尔德棉纸500克、采石白色600克

可做工艺: 直角、圆角、击凸、压凹、局部UV、雕刻、烫边、烫金/银、印金/银/白

High-end Dutch White Card 480g, Black Card 500g, Jazz Metal Platinum 500g, Wild Cotton Paper 500g, Quarry White 600g
Available processes: right-angle, rounded corner, embossing, debossing, spot UV, engraving, edge gilding, gold/silver gilding, spot color printing of gold/silver/white.



威尔德棉纸500克-压凹工艺
Wild Cotton Paper 500g-Debossing



威尔德棉纸500克-击凸工艺
Wild Cotton Paper 500g-Embossing



荷兰白卡480克/ Dutch White Card 480g



采石白色600克/Quarry White 600g



黑卡500克/Black Card 500g



卡片/Card 15



16 动漫卡/Anime card



色纸/Anime Color Paper



小卡/Photocard

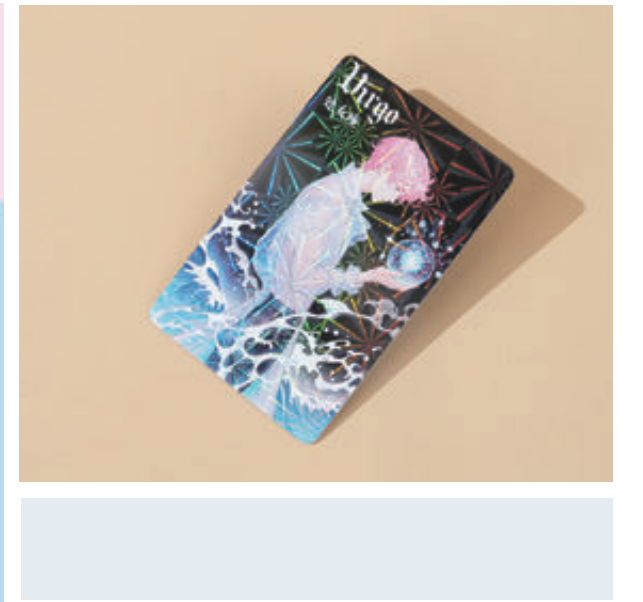

拍立得/Photo Card

闪卡/Holographic Card



镭射票/Hologram Ticket



镭射票/Hologram Ticket



刮刮卡/Scratch card 17



无料邮票/Freebie Collectible Stamp



透字卡/Light-Reveal Opaque Card



纸夹相卡/Paper Framed Clear Photo Card



定制插卡/Customized insert card 18



丝印刮刮卡
Silk-screened Scratch card



丝印刮刮卡
Silk-screened Scratch card



可变码刮刮卡
Variable code scratch card

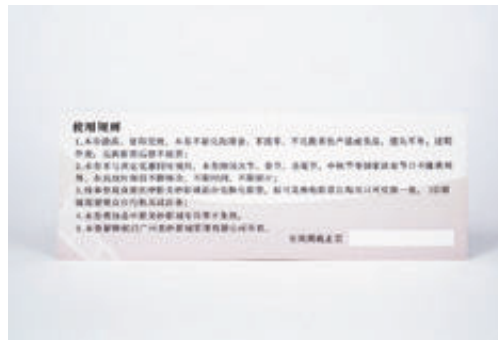

可变条形码
Variable barcode



座次票
Seat ticket



19 吊牌/书签/Hangtag/Bookmark



书签/Bookmark

20 酒挂卡/瓶挂卡/Bottle hanger card



21 异形卡/Custom Shape Card



好评卡/Review Request Card



停车牌/Vehicle Temporary Parking Card



合格证/Certificate of Compliance



卡头/Header Card 22



Part 03

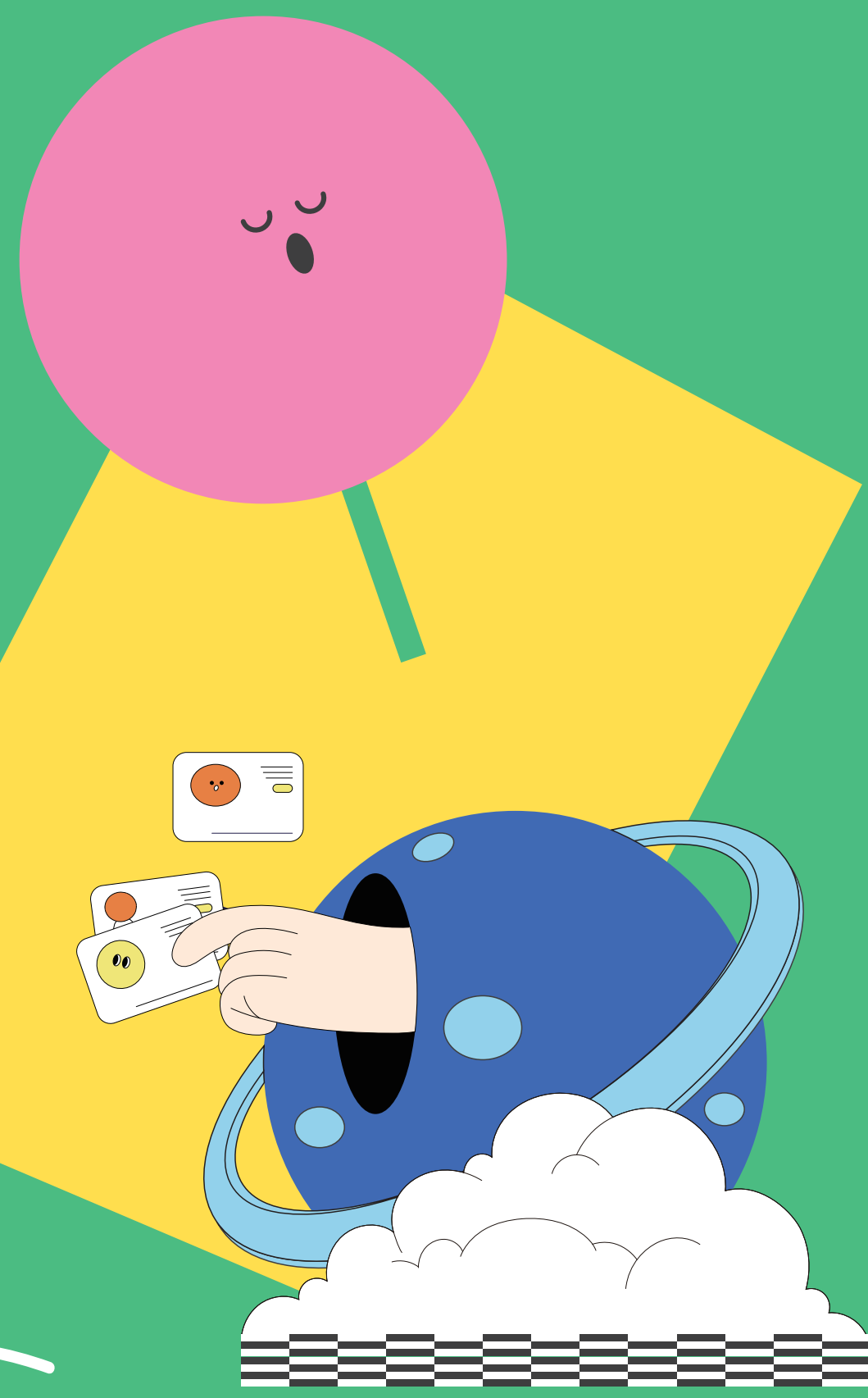

PVC名片/PVC business card 23



亮光名片/Glossy Business Card



磨砂名片/Matte Business Card



哑光名片/Frosted Matte Business Card

24 PVC会员卡/PVC membership card

可做工艺: 打码(喷码 激光码 小凸码 大凸码) 条码 可变二维码 套袋 磁条 纸质签名条 热烫 打孔

Available processing methods: Numbering (inkjet Numbering , Laser Numbering , Small Embossed Numbering , Large Embossed Numbering), barcode, variable QR code, bagging, magnetic stripe, paper signature strip, hot stamping, Punch Hole



25 PVC数码工艺卡/PVC Digital Printing Card

可做工艺: 打码 打孔 立体浮雕UV 立体浮雕 热烫

Available processes: Numbering, Punch Hole, 3D UV embossing, 3D embossing, hot stamping



PVC数码工艺卡-立体浮雕/PVC Digital Craft Card - 3D Embossing



PVC拉丝黑金料卡+立体浮雕UV/UV PVC Digital Craft Card - 3D Relief UV



PVC异形卡/PVC Custom Shape Card 26

可做工艺: 打孔 模切 背胶 折弯 防晒油墨 可变二维码 UV喷码 压痕 穿绳 热烫 打气眼

Available processing techniques: Punch Hole, die-cutting, adhesive backing, bending, UV ink, variable QR code, UV inkjet printing, creasing, string threading, hot stamping, Eyelet



PVC折弯卡-折弯80度
PVC bending clip - 80-degree bend

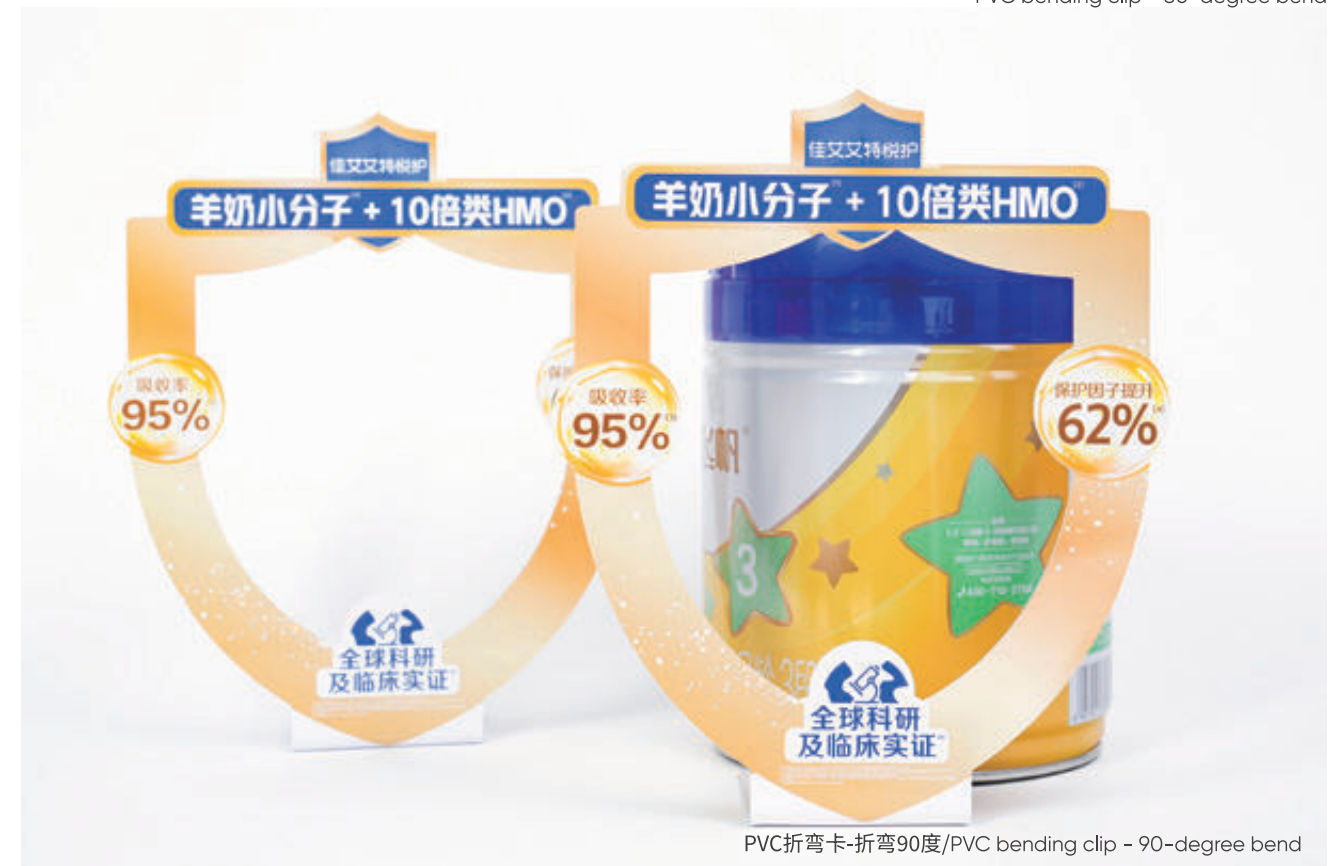

PVC折弯卡-折弯90度/PVC bending clip - 90-degree bend





PVC特价海报/PVC Special Offer Poster



40丝PP细砂料/0.4mm PP Fine Sand Texture Sheet

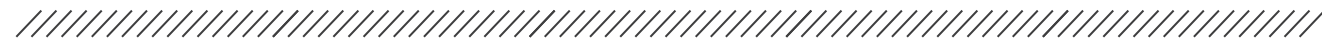

PVC一体扇
PVC One-piece Printed Fan

PVC背胶贴
PVC self-adhesive sticker

PVC背胶贴/PVC self-adhesive sticker

PVC一体扇
PVC One-piece Printed Fan

PVC门挂牌
PVC door hanger

PVC价格折扣签
PVC price discount sign

专色印刷/Spot color printing

乘法口诀垫板/Multiplication table mat

打孔+UV喷码/Punching + UV printing



PVC手机支架/PVC Mobile Phone Stand

27 PVC证件卡/PVC ID card



挂绳-扁孔印字
Lanyard - Flat hole printing

挂绳-扁孔不印字
Lanyard - Flat hole without printing

卡套-双窗透明卡套/Card holder-Double-window transparent card holder



卡套-单窗透明推合卡套/Card holder--
window transparent push-fit card holder with ferrule sleeve



卡套-铝合金卡套
Card holder-Aluminum alloy card holder



猫眼膜/Cat Eye Film

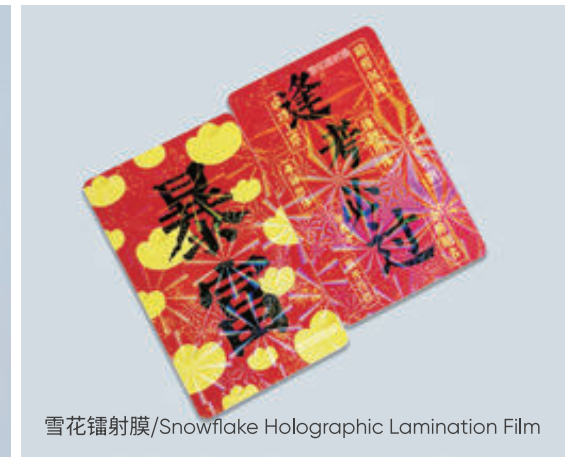

雪花镭射膜/Snowflake Holographic Lamination Film

NFC芯片卡
碰一碰 即刻分享

NFC Chip Card
Tap to share instantly



28 PVC半透卡/Frosted Card



PVC刮刮卡/PVC scratch card 29



喷码+涂银/Inkjet printing + silver coating

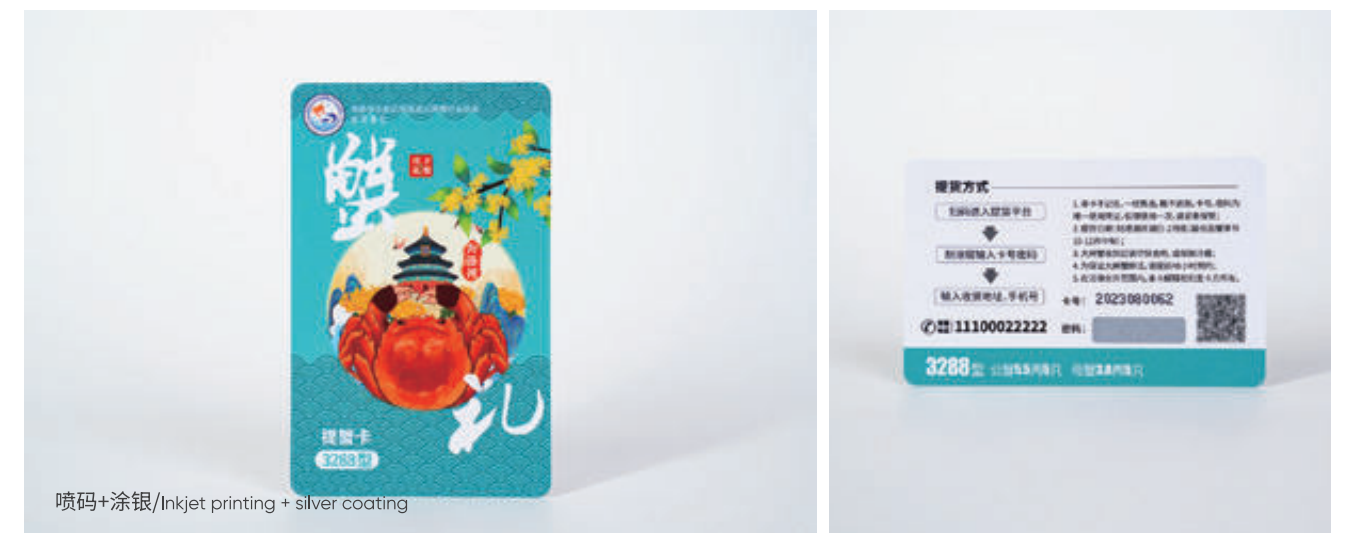

喷码+涂银/Inkjet printing + silver coating

Part 04

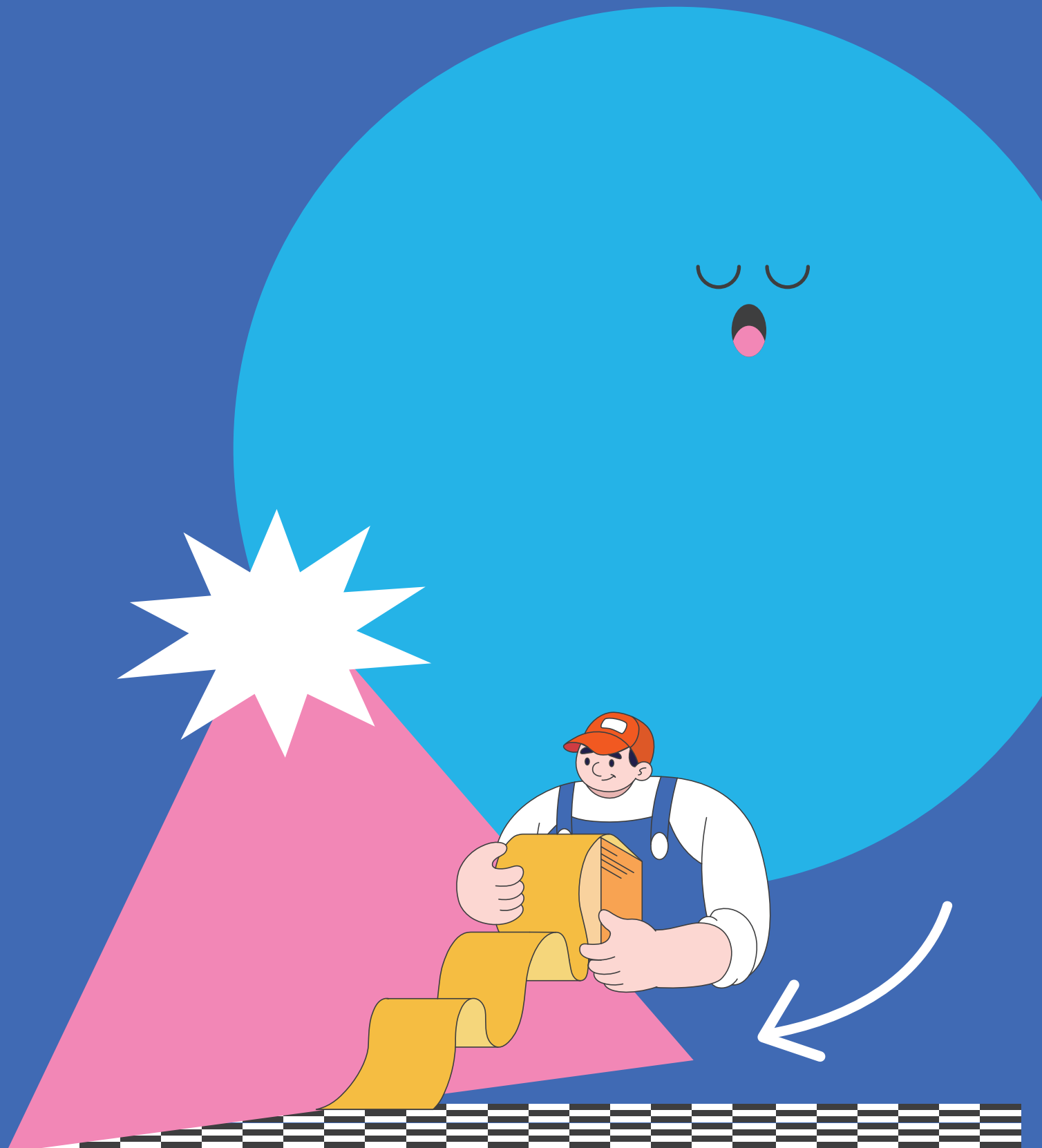

ShengDa Print Malaysia,
No.6, Persiaran Industri, SD5, Bandar Sri Damansara,
52200 Kuala Lumpur, Malaysia.
+6011 1071 2377

PRODUCT MANUAL 2026 # 产品手册

不干胶-贴画/Sticker 30

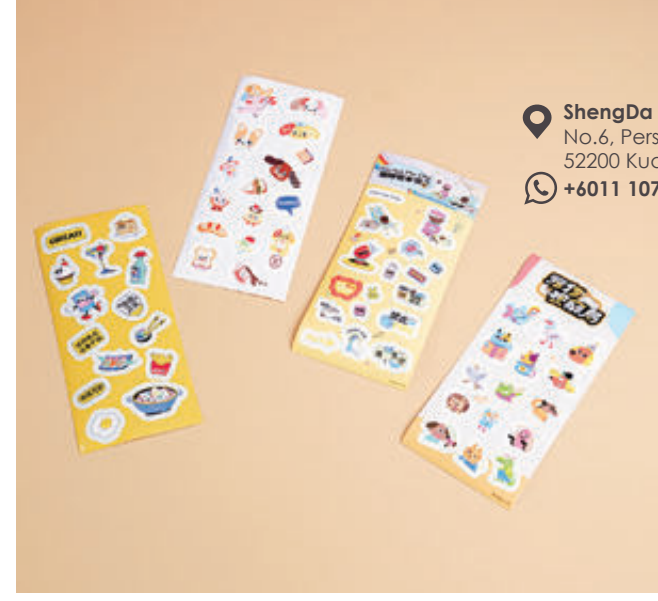

31 纸箱标签/Carton label



封口签/Sealing label 32

易碎封口签 (易碎纸不干胶) /Fragile sealing label (fragile paper self-adhesive)

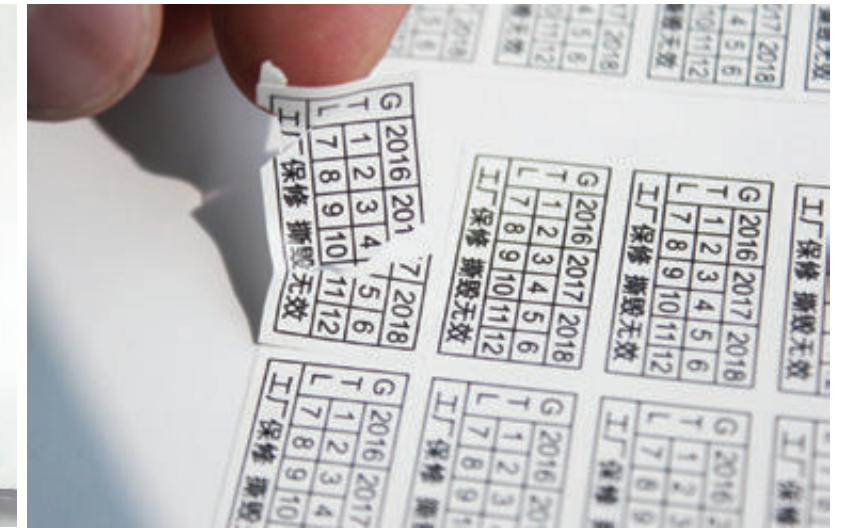

湿巾封口签/Wet wipe seal label



透明封口签/Transparent sealing label



VOID防伪标签/VOID Anti-counterfeiting Label



撕开无效:撕开后不再有粘性,有效的保护是否被动过。 Tear here to open: Once torn, it will lose its stickiness.

打印标签/Printing label 33



户外宣传贴/Outdoor poster 34



35 工艺标签/Label With Finishing



[卷装标签] 卷标三要素

第一要素: 卷芯 (中间卷筒内直径) 常见30mm、40mm、75mm 三种规格可选
The first element: Core (inner diameter of the middle roll) is commonly available in three specifications: 30mm, 40mm, and 75mm.

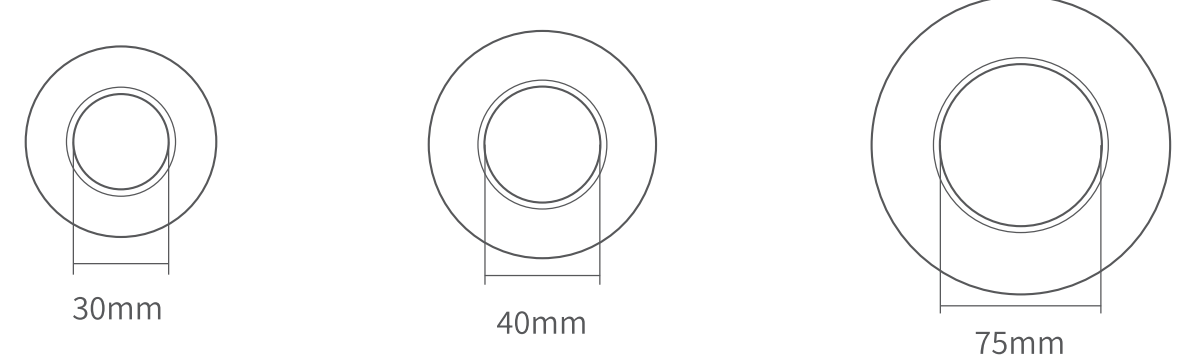

第二要素: 出标方向 (正看文件内容区分横版/竖版, 往哪个方向拉出即为出标方向)
The second element: Direction of label extension (For documents placed upright, distinguish between horizontal and vertical versions. The direction in which the label is pulled out is the direction of label extension.)

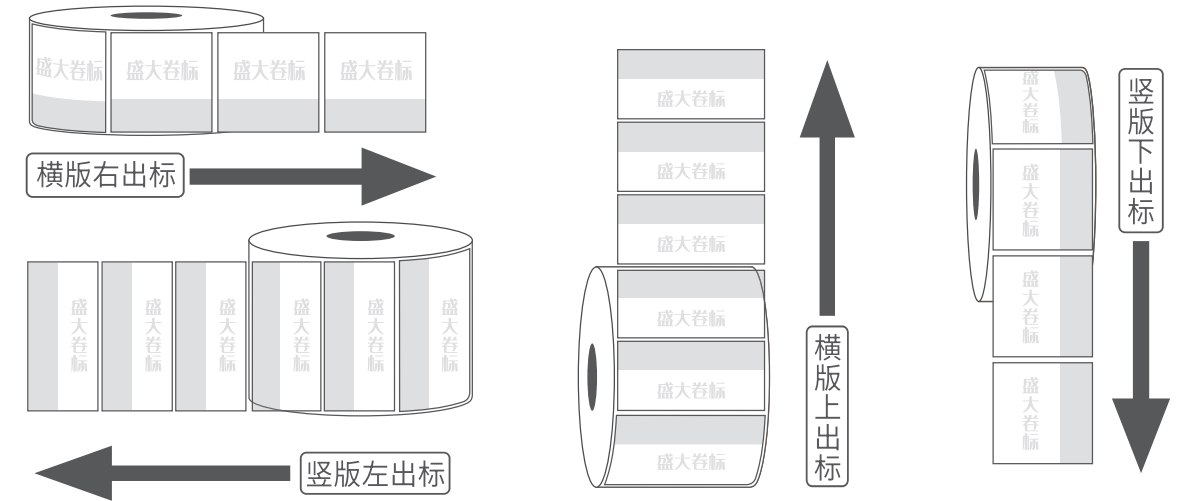

第三要素: 每卷张数, 根据具体需求, 可调整具体数量 (长度/张数/外直径尺寸) 为一卷
The third element: The number of sheets per roll. According to specific requirements, the exact quantity (length/number of sheets/outer diameter size) per roll can be adjusted.



Part 05

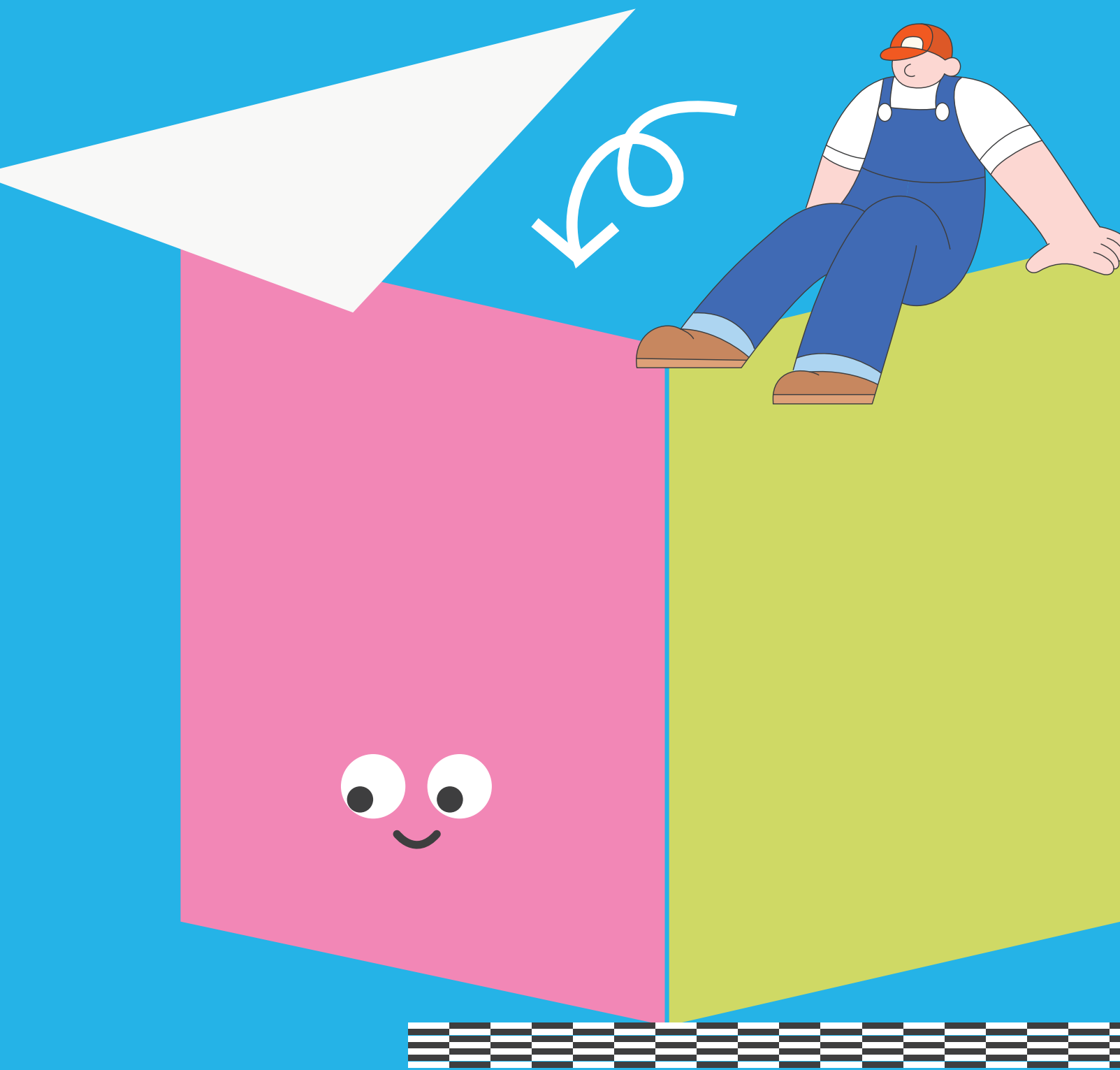

ShengDa Print Malaysia,
No.6, Persiaran Industri, SD5, Bandar Sri Damansara,
52200 Kuala Lumpur, Malaysia.
+6011 1071 2377

PRODUCT MANUAL 2026 # 产品手册

精装画册/HardCover Booklet 36

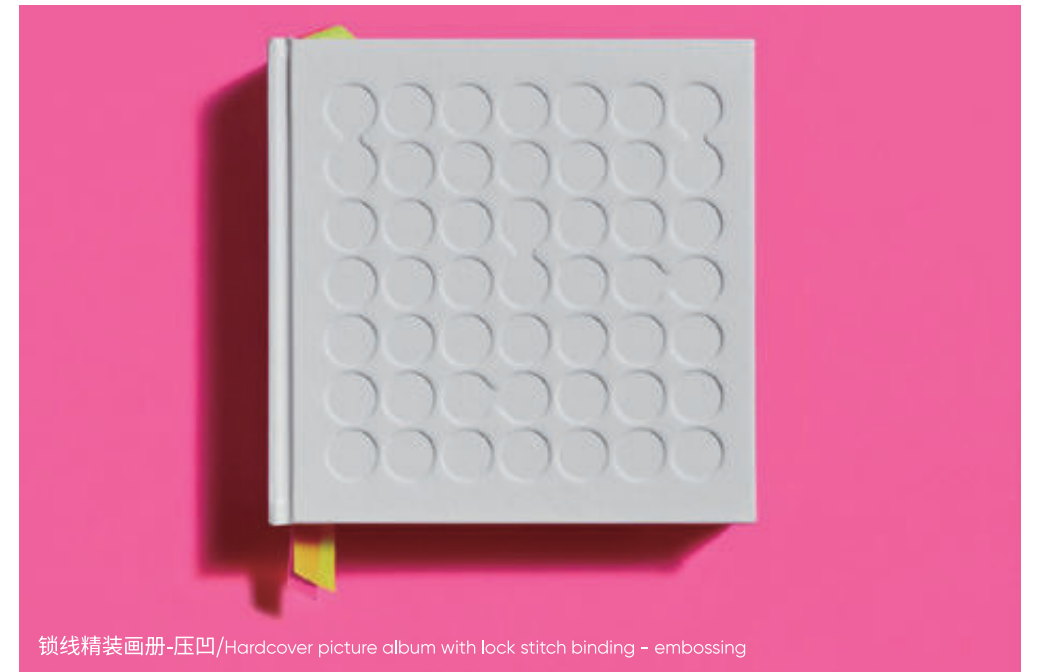

锁线精装画册-压凹/Hardcover picture album with lock stitch binding - embossing



锁线精装画册-烫绿万花筒/Thread-Sewn Hardcover Booklet-Foil-stamped Kaleidoscope Green Gold



锁线精装-封面烫红金-压粗布纹
Hardcover with sewn binding - red gold stamping on the cover - embossed with a coarse fabric texture



线圈环装画册/Hard Cover Wire O Booklet



蝴蝶对裱画册/Butterfly Mounted Portfolio



硬壳环装-封面覆哑膜
Arch File - Cover with Matte Lam



软精装-封面-星域宝石蓝230克-烫亮黄金
Soft hardcover - Cover - Starry Sky Sapphire Blue 230g - Gold Stamping

37 骑马钉画册/Saddle Stitch Booklet

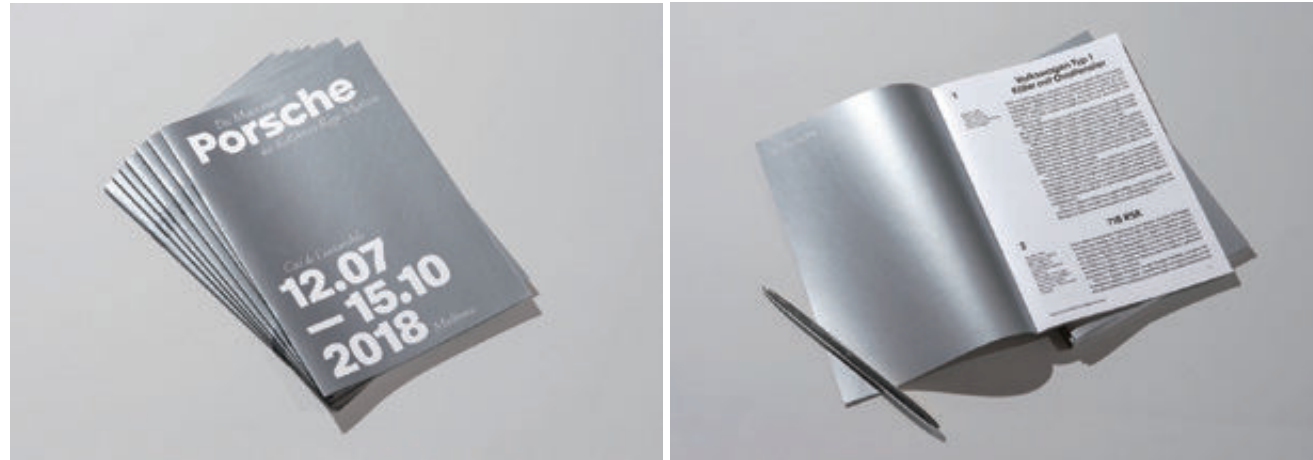

胶装画册/Perfect Binding Booklet 38



裸脊线装/Exposed Spine Thread Sewn Binding

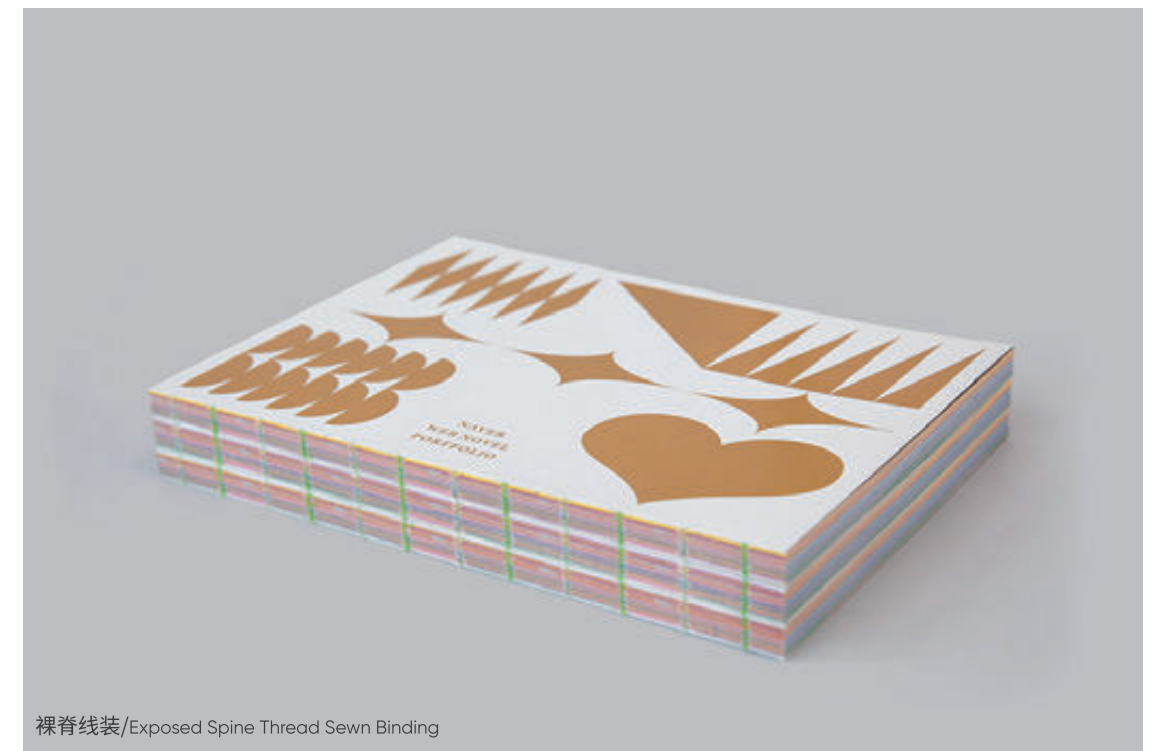

裸脊线装/Exposed Spine Thread Sewn Binding



无线胶装画册-模切工艺
Perfed Binding Booklet - Die Cutting Finishing



锁线胶装-印银/Perfect Binding -Silver Printing

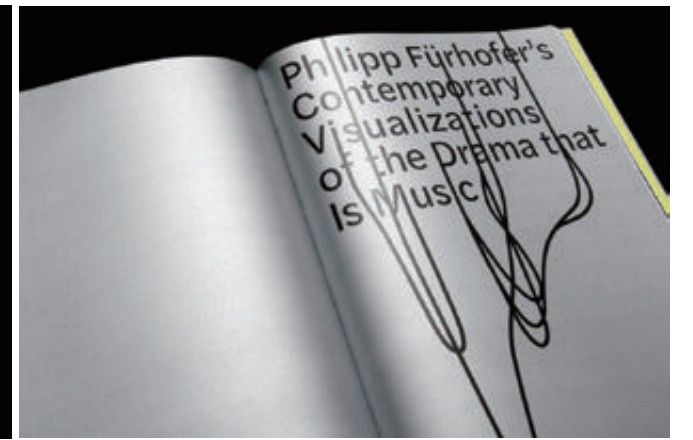

锁线胶装-烫七彩银-烫哑金
Sewing Binding -Hot Stamping with Rainbow Silver -MatteGold

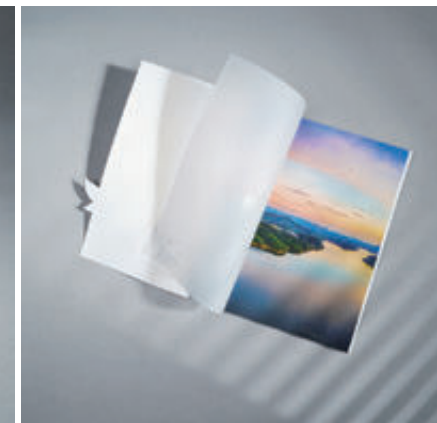

锁线胶装-扉页硫酸纸
Sewing Binding - endpaper with tracing paper



无线胶装-经典黑卡-局部亮光UV
Perfect Binding-Classic black card + Particle Gloosy UV

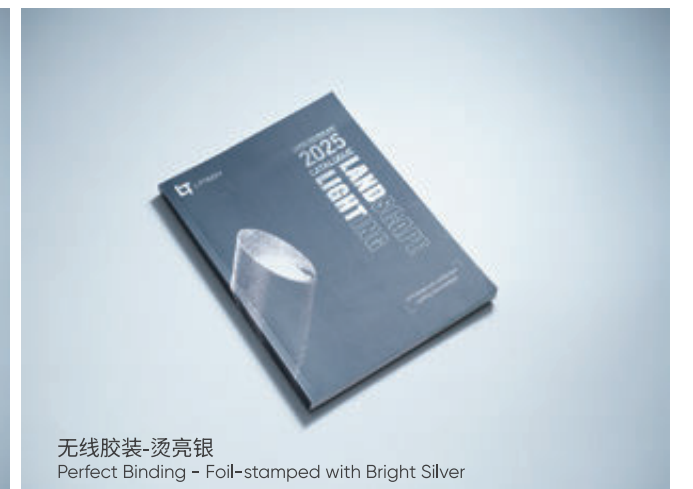

无线胶装-烫亮银
Perfect Binding - Foil-stamped with Bright Silver

39 合同说明书/Contract Instruction Manual

笔记本/Notebook 40



骑马钉双胶纸合同书/Saddle-stitched Offset Paper Contract



软裱款-书脊笔插/Soft Mounted Version - Book Spine Pen Holder

无钉合同书/Staple-free Contract Book



喷胶画册/Spray-glued Booklet



单裱款
硬裱封面镂空工艺
Single Wrapped Mounted Version - Hard Mounted Cover with Cut-out Craft



活页环装笔记本/Ring-bound Loose-leaf Notebook



车线本/Sewn Binding Notebook



皮革笔记本-单包袂款笔记本-加磁扣
PU Leather Soft cover Notebook with Magnetic Closure



车线本/Sewn Binding Notebook



画册/笔记本新工艺

书口创意喷印

New Finishes For Booklets/notebooks
Creative Jet Printing On Book Edge



软面抄笔记本/Softcover Notebook



线圈环装笔记本/Wire-O Bind Notebook



镂空雕刻笔记本
Cut-out Carved
Notebook

Part 06 ↙



封套/Cover sleeve 41



胶条封套/Adhesive Strip Envelope

42 精品卡套/房卡套/Boutique card holder/Key card holder

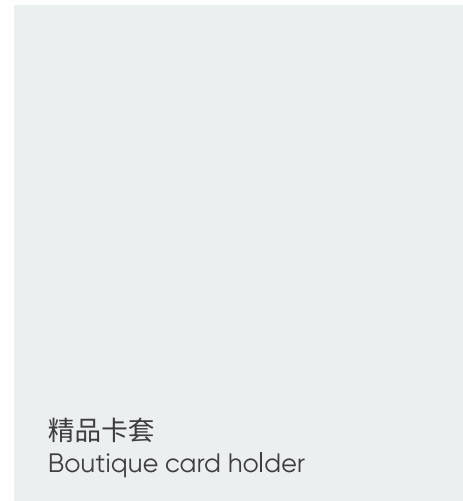

精品卡套
Boutique card holder



房卡套/Key card holder



口袋式卡套/Pocket type card holder



房卡套/Key card holder

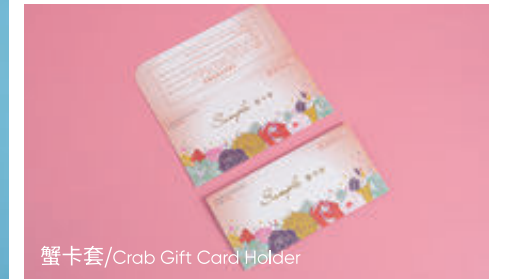

蟹卡套/Crab Gift Card Holder



43 筷子套/Chopsticks sleeve

信封/Envelopes 44





Envelopes



快递封-灰板纸250克
Courier Envelope-250gsm Grey CardBoard



快递封-灰板纸250克
Courier Envelope-250gsm Grey CardBoard



快递封-白卡纸210克
Courier Envelope-Gloss Art Card(1side Coated)
210gsm



快递封-白卡纸210克
Courier Envelope-Gloss Art Card(1side Coated)
210gsm

45 档案袋/Document Folder



档案盒/凭证盒/File box/Voucher box 46



47 手写联单/Bill Book



机打联单/ Computer Form 48



机打联单/Computer Form



机打票据/Computer Form



49 票本/Ticket Book



热敏收银纸/Thermal receipt paper 50

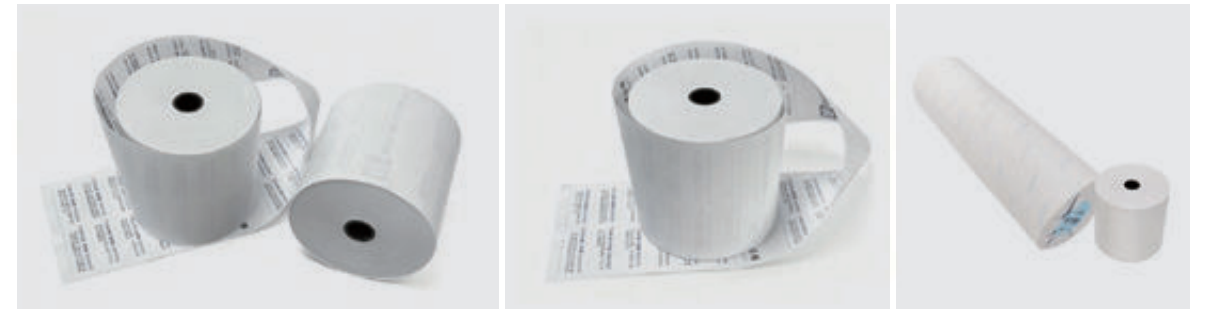

书砖/Book Brick 52

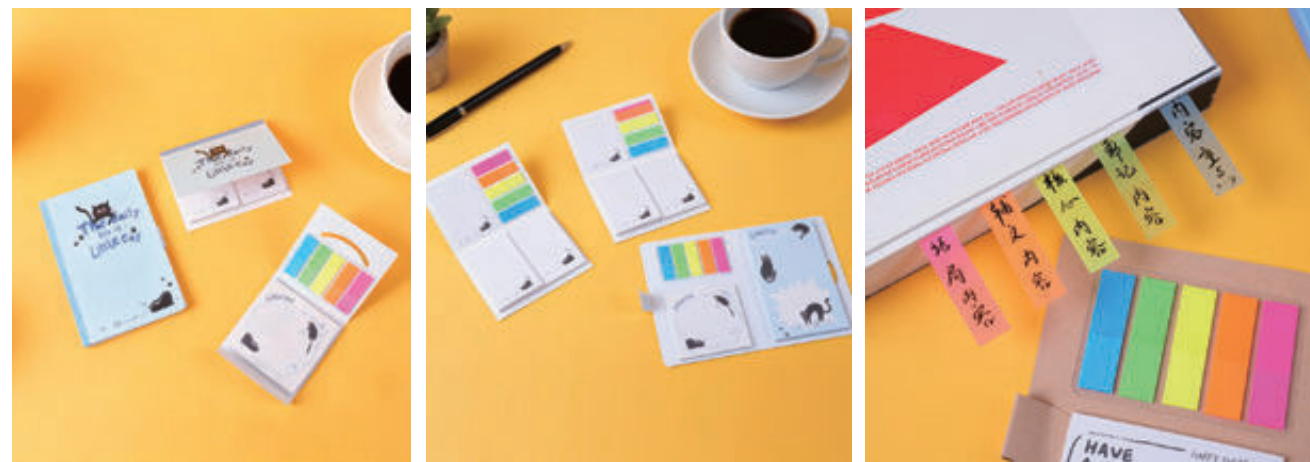

53 红头文件/Document with red headline



54 喷绘/Large Format Printing



写真/Large Format Printing (High Quality) 55

A 户外写真/Outdoor showcase



灯片/Backlit Film

背胶/ Backlit Sticker



B 户内写真/Indoor showcase

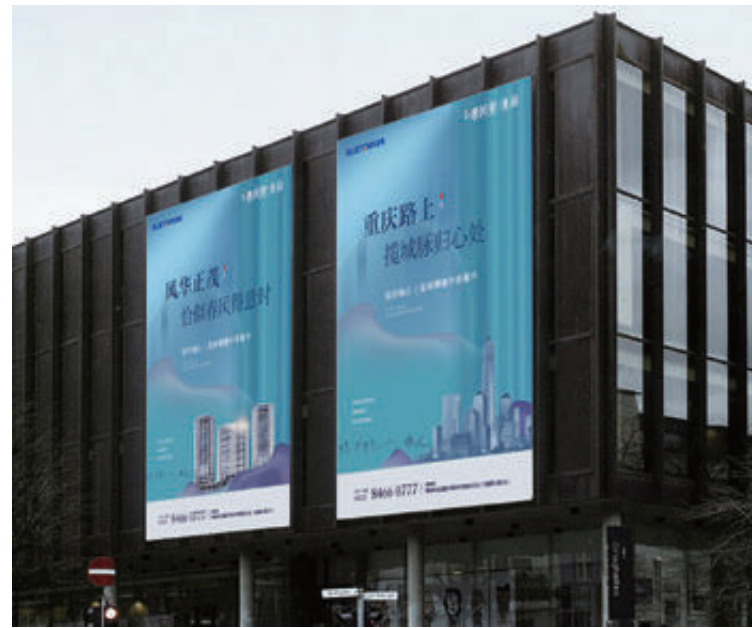

户外写真/Outdoor showcase



灯片/Film



油画布/Canvas



背胶油画布/Canvas with Sticker



C 动漫挂画/Anime Wall Scroll

车贴/Adhesive vinyl

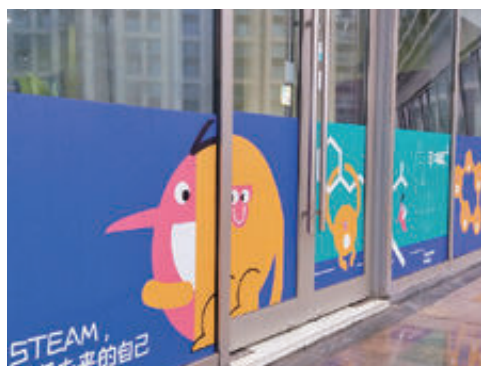

56 UV彩白彩/UV color-white-color print



UV单喷/双面喷/UV Single Side Printing 57
/UV Double Side Printing

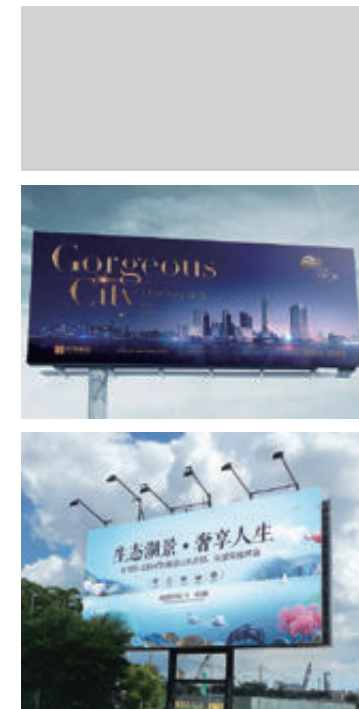

58 UV磁吸贴/Magnet with Sticker UV Printing



UV磁吸画/UV Coated Magnetic Wall Art 59



60 展架/展板/Display rack/Display board

灯箱画面/Light box image 61



62 灯箱 (整套) / Light box (complete set)

旗帜 / Flag 63



镂空灯箱/Perforated light box

镂空灯箱/Perforated light box



无边框卡布灯箱
Frameless Canvas Light Box



64 条幅/Scroll



手拉旗/Handheld Pull-Up Flag 65



66 锦旗绶带/Silk Banner and ribbon



67 门帘/桌旗/手摇旗
Door Curtain/Table Flag/Hand Waving Flag



68 水晶标/Crystal label



金属标/Metal label 69



70 钛金牌/Titanium medal



金属徽章/Metal Badge 71

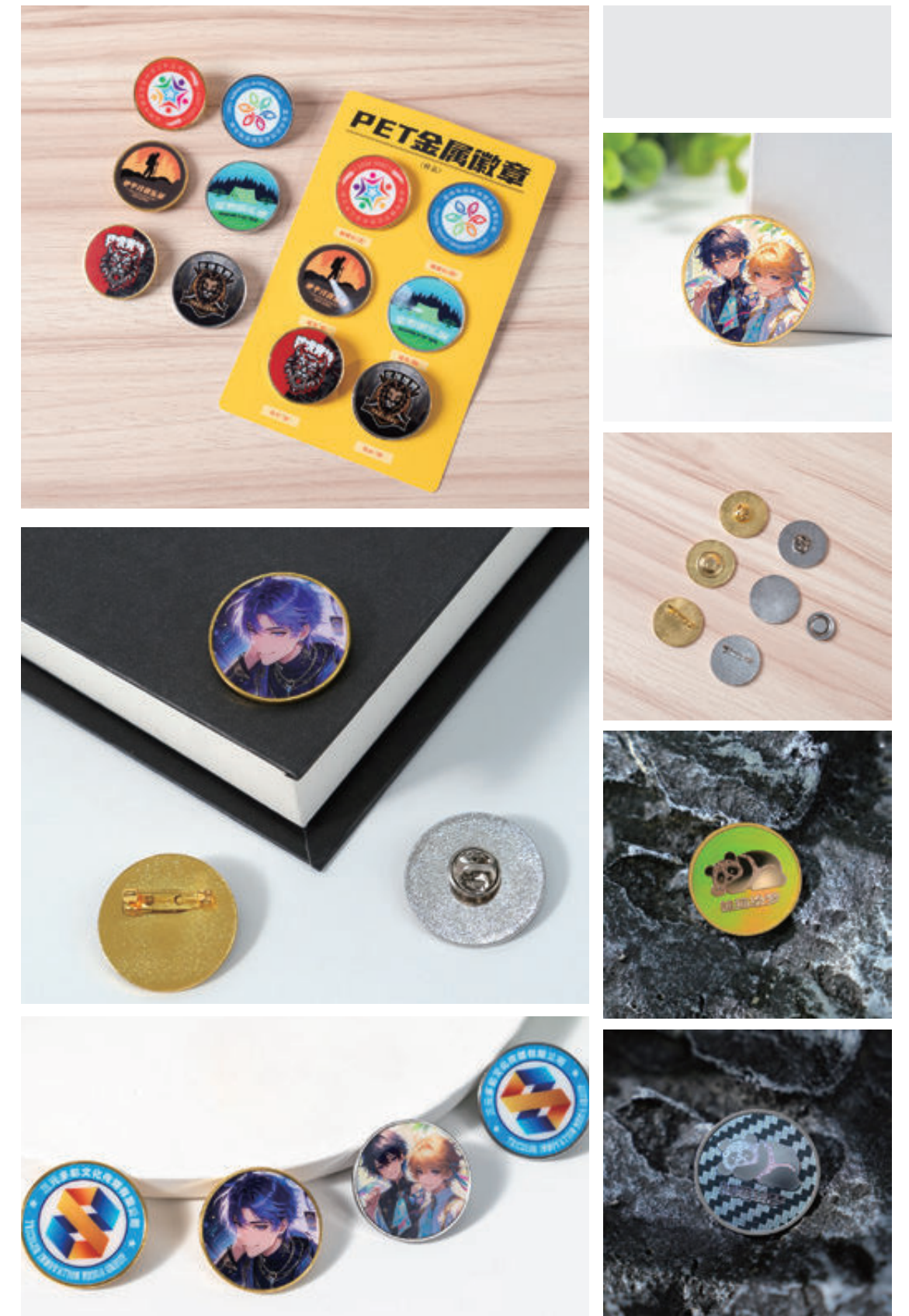

72 吧唧徽章/Badge



亚克力周边/Acrylic Peripherals Products 73

对联冰箱贴/Spring Festival Couplet Fridge Magnets





冰箱贴/Fridge Magnets



亚克力工作证/Acrylic ID Badge



钥匙扣/Keychains



亚克力尺子/Acrylic Ruler







亚克力象棋2000尺寸/Acrylic chess set 2000 size

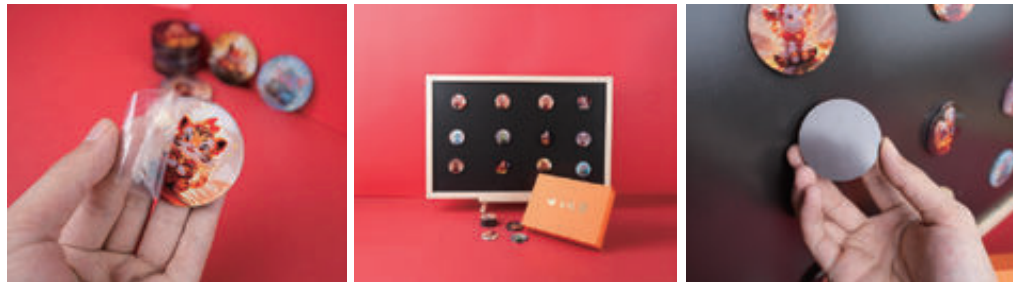

十二生肖亚克力/Twelve chinese zodiac acrylic



亚克力折弯牌/Bent acrylic plate



胸牌/Name tag

74 授权奖牌/Authorization medal



直边木托牌/花边木托牌
Straight-edge wooden plaque/
Carved-edge wooden plaque



竖版木托牌
Portrait-oriented wooden plaque



横版木托牌
Horizontal wooden plaque



直边木托牌-花边银箔/花边金箔/Straight-edge wooden plaque---Ornamental silver foil/Decorative gold foil



水晶授权牌/Crystal authorization plaque

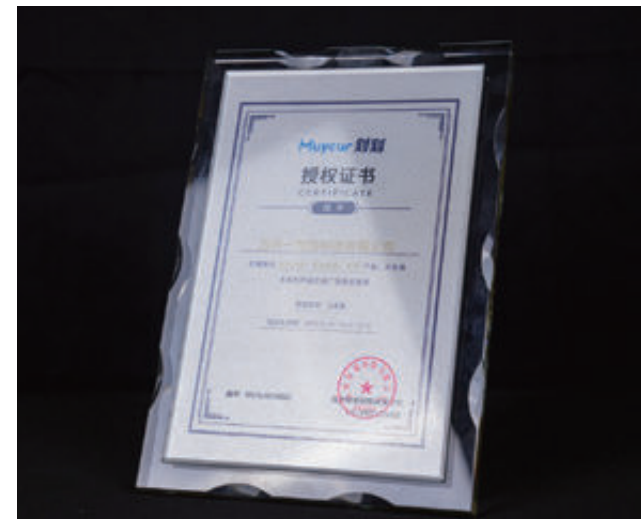

75 发光字/Luminous character



雕刻字/Engraved Character 76

彩色PVC雕刻字/Colored PVC engraved letters



77 PVC雪弗板/Foamed PVC sheet

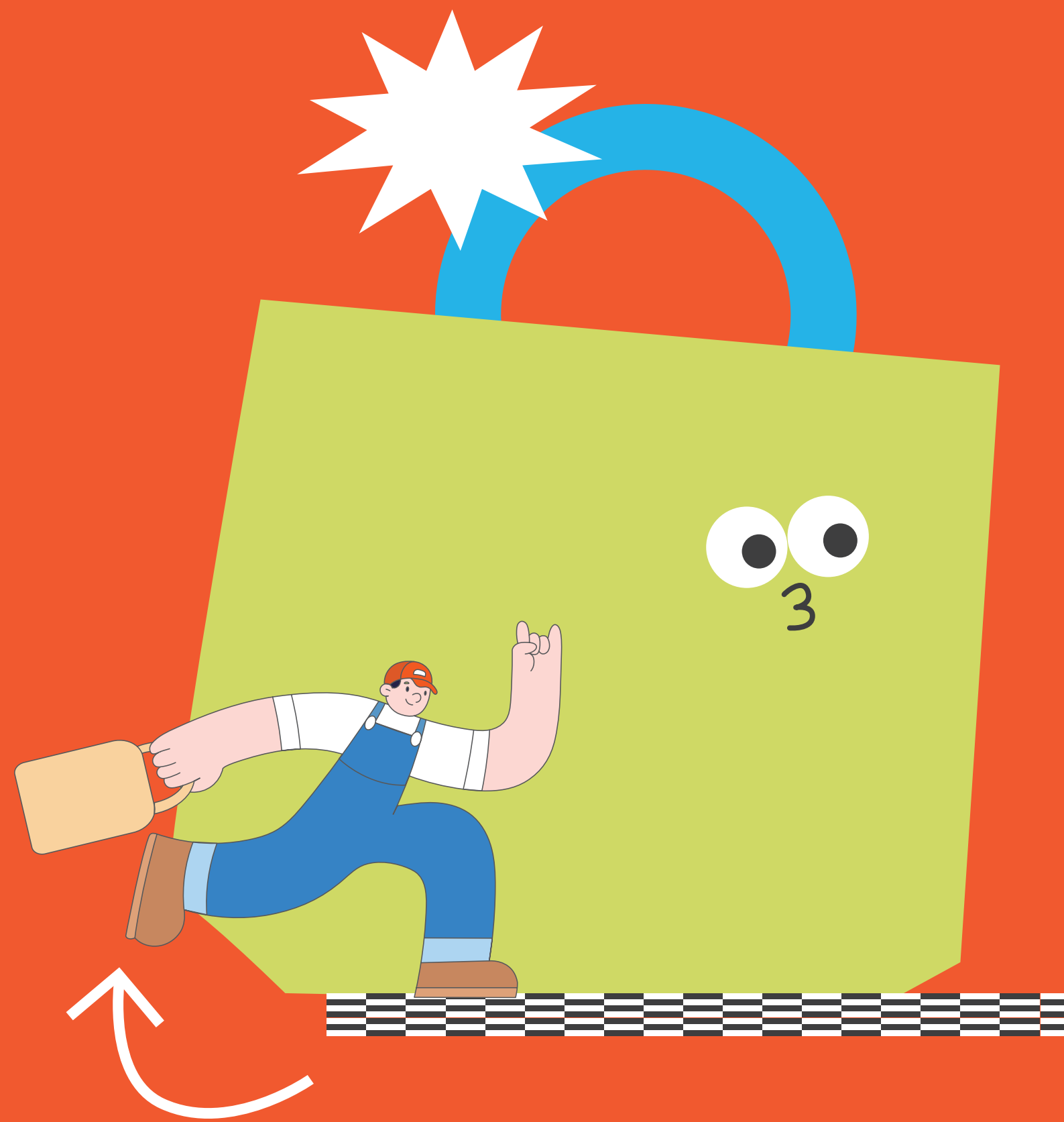

78 白卡纸袋/礼品袋/ArtCard Paper Bag/Gift Bag





无腰线手提袋/Seamless Handle Bag



三股绳/Three-strand rope

2.0平纹带/2.0 plain weave belt

2.5平纹带/2.5 plain weave belt

礼品袋/Gift bag



79 环保纸袋/Eco-friendly paper bag



80 帆布袋/Canvas bag



精品布袋/Premium canvas bag

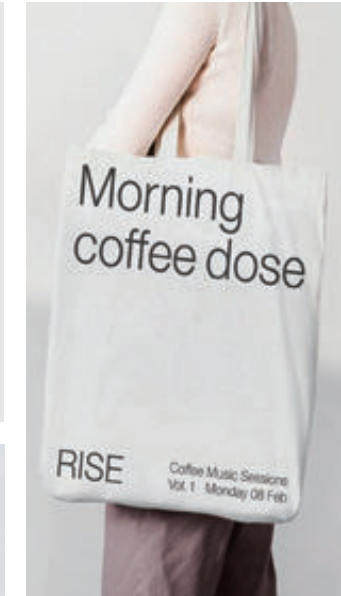

束口帆布袋/Drawstring canvas bag



绳子/Rope

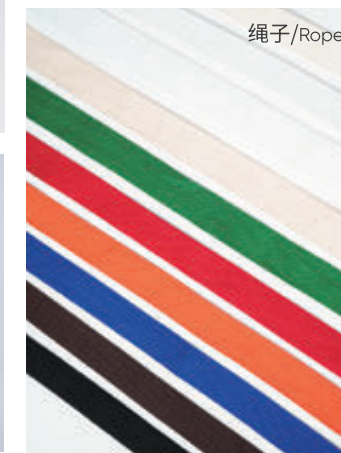

有底有侧帆布袋
Canvas bags with side and bottom panels

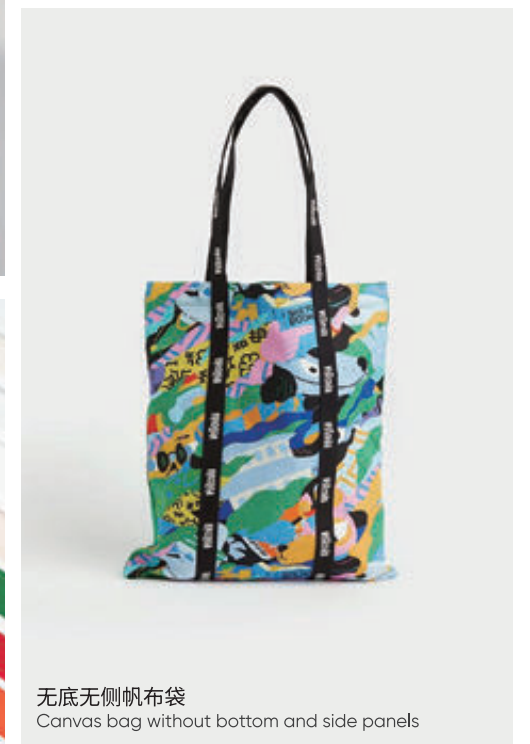

无底无侧帆布袋
Canvas bag without bottom and side panels

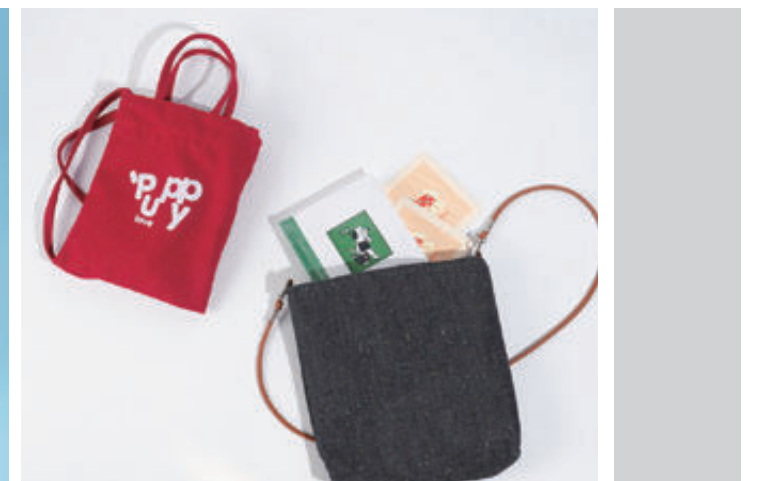

81 毛毡袋/Felt bag



PP料透明袋/PP material transparent bag 82



透明印白和透明不印白对比
Comparison between transparent printed white and transparent unprinted white

底部热合八字底
Heat-sealed cross bottom (8-shaped bottom)



烫镭射银+牛皮纸手提
Laser-engraved silver+ kraft paper handle



83 复合揉纹袋/Composite Textured Bag



Crinkled texture exudes a natural premium feel, and a single carry reveals distinctive personality and bold charm.

抱枕/Cushion 84



45cm*45cm cushioncase with cushion core

45cm*45cm枕套含枕芯

一个起做

Minimum order quantity: 1 piece



爱我，你就抱抱我！

85 彩色淋膜袋/无纺布丝印袋
Color film laminated bag/Nonwoven silk-screen printing bag



彩色缝纫包边袋/Color-edge-bound bag



彩色淋膜一体袋
Color-laminated one-piece bag



丝印无底无侧袋
Silk-screened bag without bottom or side panels



彩色缝纫包边袋
Color-edge-bound bag



丝印机制一体袋
Machine-made one-piece bag with silk screen printing

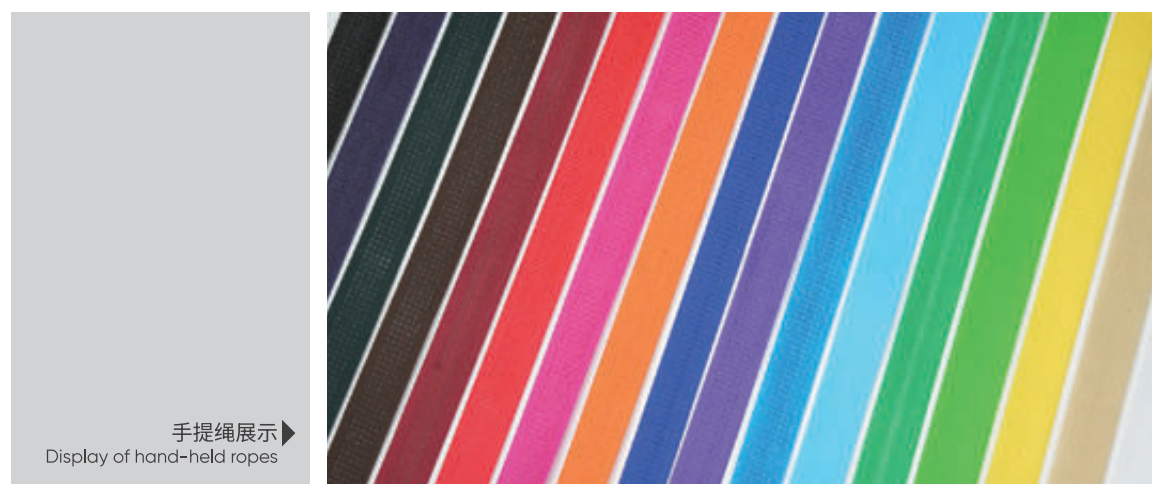

手提绳展示
Display of hand-held ropes



彩色缝纫包边袋/Color-edge-bound bag



彩色机制一体袋
Colored machine-made one-piece bag



围裙/Apron

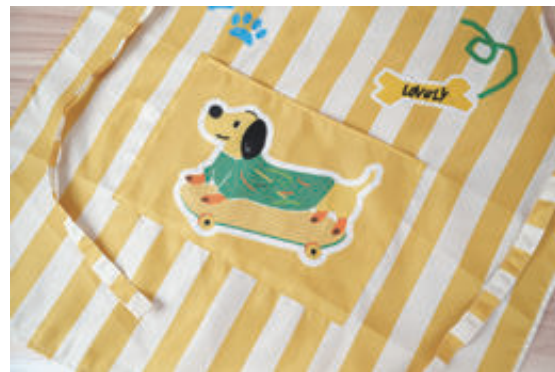

86 纸抽/Tissue box



竹质抽纸盒/Bamboo Tissue Box



塑料软抽/Plastic Soft-Pack Tissues



87 纸杯/Paper cup



88 纸碗/Paper bowl



杯垫/Coaster 89



纸质杯垫/Paper coasters



腰封/Belly band 90



毛毡杯垫/Felt Mat





飞机盒/Mailer box



92 精装盒/Hardcover box



93 蛋糕盒/Cake box



透明盒/Transparent Box 94



95 鼠标垫/Mouse pad

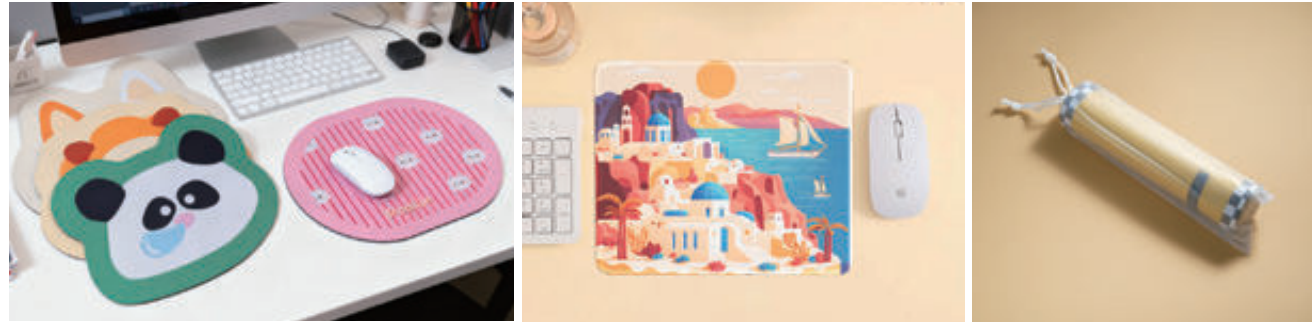

96 桌垫/地垫/Table mat/Floor mat



框画/摆台/Grade Framed Artwork/Grade Tabletop Display 97



折叠投影灯/Foldable Projection Light 98

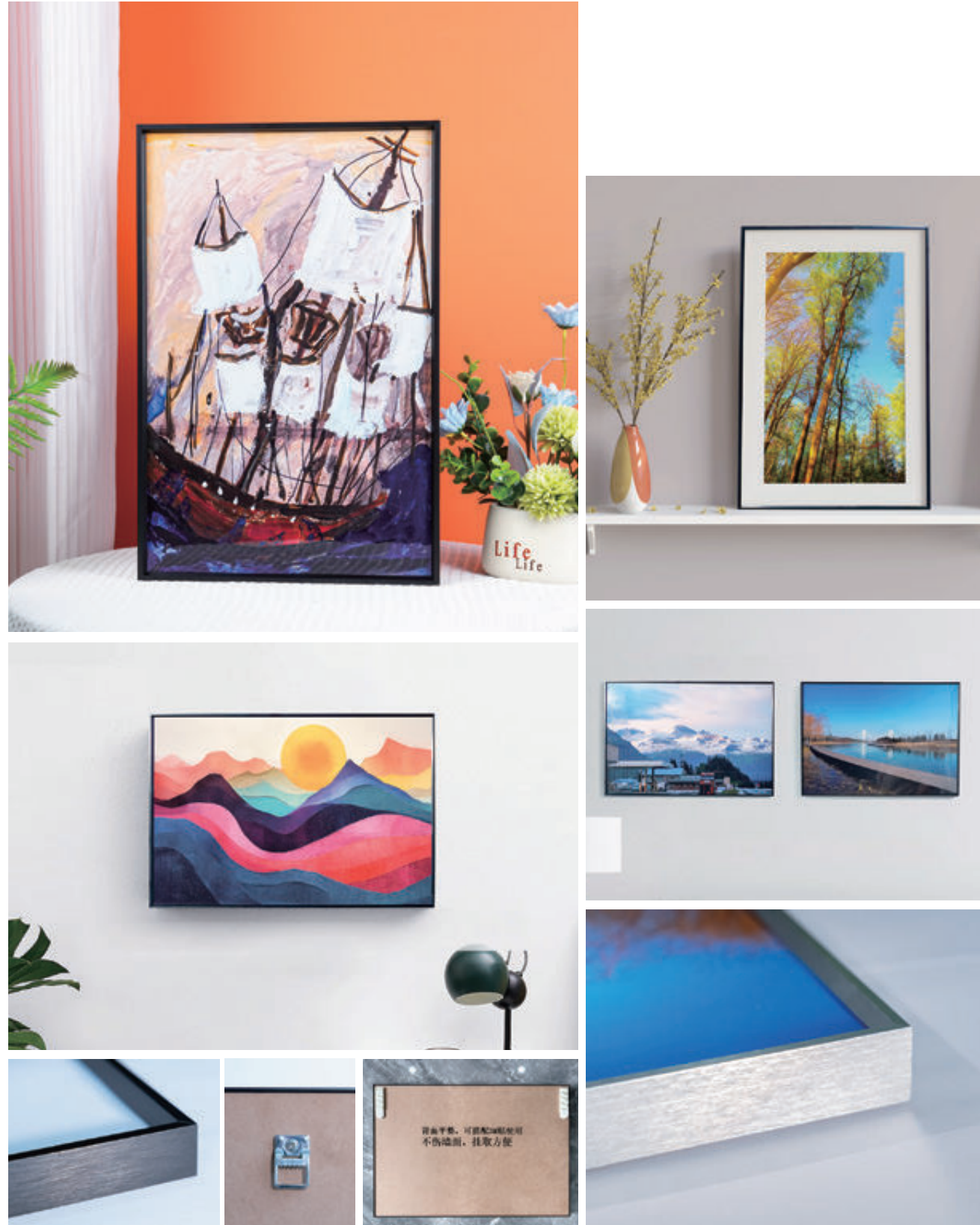

梅妃竹产品/Meifei Bamboo Products 99



竹丝灯笼/Bamboo Silk Woven Lantern



老楠竹丝挂画/ Old Phoebe Bamboo Silk Woven Hanging Scroll

单绢挂画/Single Layer Silk Fabric Hanging Scroll



100 广告扇/Advertising Fan



腰扇/Waist Fan

宣纸团扇/Traditional Chinese Rice Paper Round Fan



折扇/Folding Fan

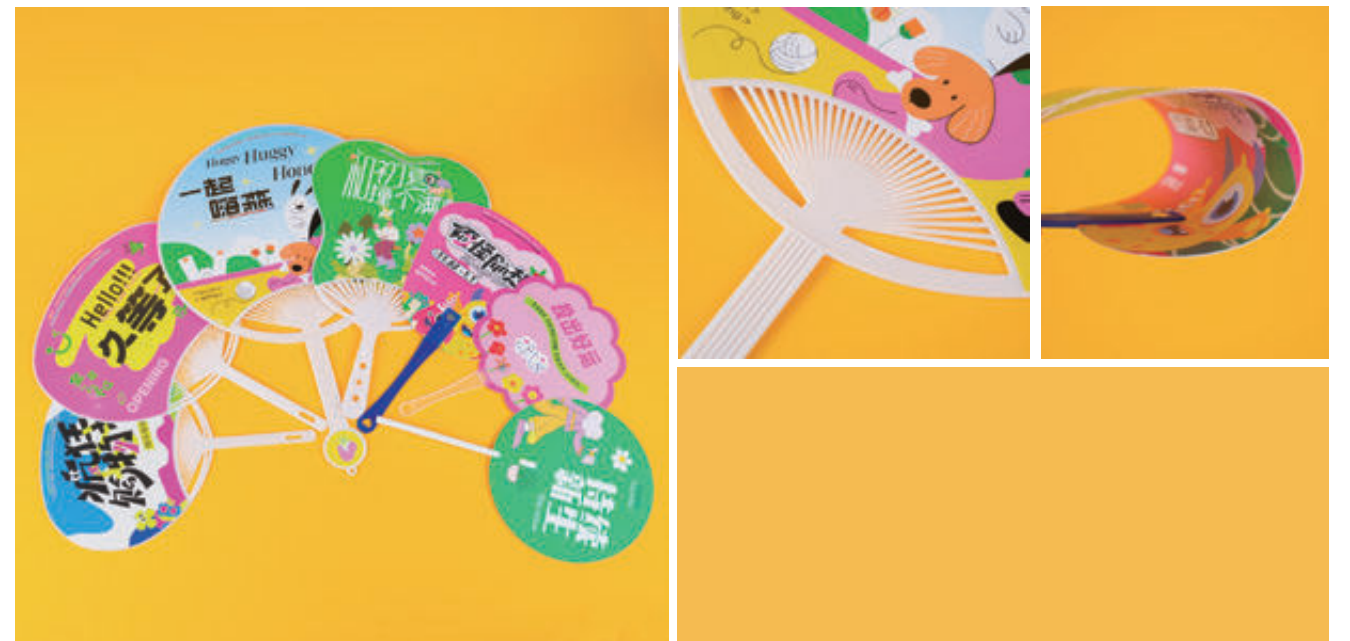

101 台历挂历/Desk calendars and wall calendars



纸板夹挂历/Cardboard Clip Wall Calendar



环装挂历/Coil-bound Wall Calendar



指环扣款/Ring Buckle Style



线圈环装款/Wire-O Bind style



指环扣款/Ring Buckle Style



动漫挂画/Anime Wall Scroll



松木挂画/Pine Wood Hanging Scroll

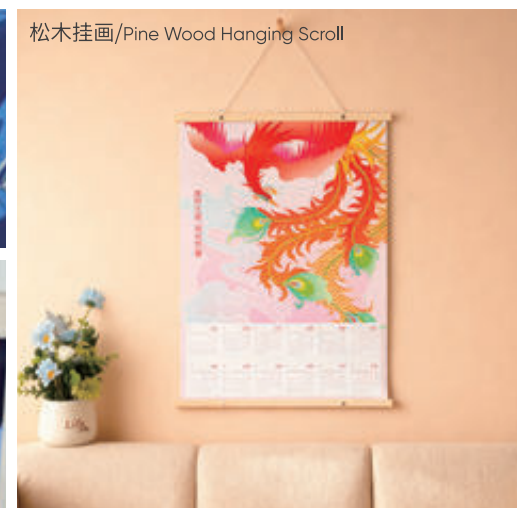

梅妃绢布款/Meifei Silk Fabric Style

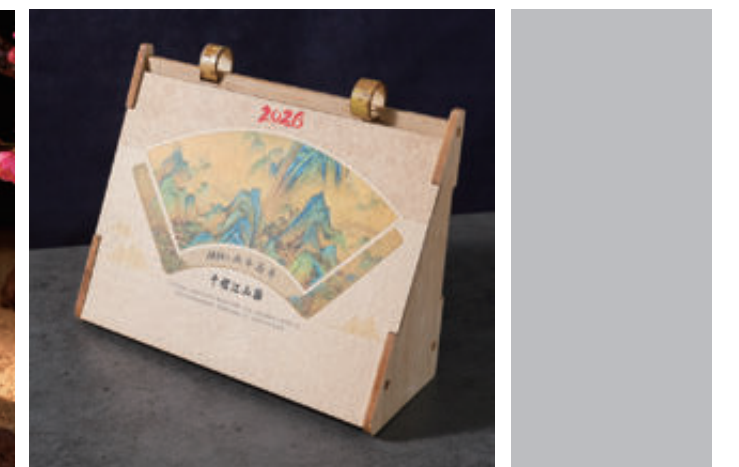

102 年货/Festival items



◀ 红包
Red Packet



窗花 ▶
Chinese Paper Cutting Window Decal



103 供应链/Supply chain



碳粉硒鼓墨盒/Toner Cartridge 104



自主研发芯片
复印稳定安全
Self-developed chips
Stable and secure copying

稳



进口/原装碳粉
好用不伤机
Imported / Original Toner
It's effective and won't harm the machine

好

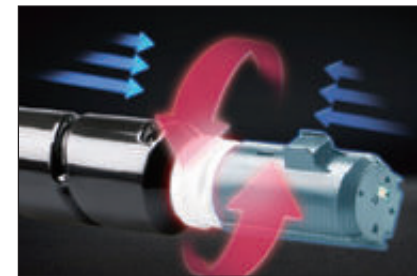

优质鼓组件
打印品质稳定
High-quality components
The print quality is stable

优



常用工艺展示



NT-PH1110



NH-R00955



NT-C0388CT



NF-CF256



理光Ricoh-2501



NF-W1333



975墨盒组合ink cartridge combination



993XLBK



理光Ricoh-2014



NT-C2612



烫金/Gold stamping



浮雕烫/Embossing Hot Stamping



击凸/Embossing



压凹/Debossing



UV



浮雕UV/Relief UV



立体UV/3D Cold Stamping



冷烫/3D Cold Stamping



专色/Spot color



印金/银/Print (Gold/Silver)



模切/Die-cutting



雕刻/Carving



亮膜/Glossy film



哑膜/Matte film



触感膜/Soft Touch film



星光膜/Starlight film



镭射膜/Rainbow film



压纹/embossed texture



压痕/Creasing



压点线/Perforated line