



COLLECTION  
2022-2023

# BUYER'S GUIDE

Quality isn't expensive, it's priceless. | Always dress like it's the best day of your life.





Authorized Distributor of :

**GILDAN®**

**CROSSRUNNER®**

**NORTH HARBOUR**

**★ STATESIDE™**

**GILDAN  
HAMMER**

**ANVIL®**  
BY GILDAN

**COMFORT COLORS®**

**American Apparel®**

**SARRA®**

**PANBASIC**



# CONTENTS

Collections of 21-22



## 7 • T-SHIRT

**North Harbour** NHR 1100 / NHR 11400 / NHR 1100B / NHO 1100

**Gildan Softstyle** 63000 / 63V00 / 63V00L

**Gildan Premium Cotton** 76000 / 76000L / 76000B

**Gildan Hammer** HA00

**Panbasic** P-901

**Gildan Premium Cotton** 76400 / 76600 / 76700 / 76500

**Gildan Ultra Cotton** 2000 / 2400 / 2200

**Gildan Heavy Cotton** 5000

**Comfort Colors** 1717 **American Apparel** 2001W

**Stateside** MAINE / TEXAS

**Anvil** 939 / 6755 / 980 / 987

## 57 • POLO

**North Harbour Soft-Touch Polo**

NHB 2400 / NHB 24400

**Gildan Premium Cotton** 6800

**North Harbour Signature Polo**

NHB 2100 / NHB 2200 / NHB 2300 / NHB 2500

NHB 2800 / NHB 2700 / NHB 2900 / NHB 3200

NHB 3300



## 77 • ACTIVEWEAR

**Crossrunner Performance Polo** CRP 7200

**Panbasic AIRtec Polo** P-703

**Crossrunner Athletic Polo**

CRP 2100 / CRP 2300 / CRP 2400 / CRP 2500 / CRP 1300

CRP 1400 / CRP 1500 / CRP 1600 / CRP 2900 / CRP 3100

CRP3200 / CRP 2700 / CRP 2800 / CRP 3000

**Crossrunner Performance Tee** CRR 3600 / CRR 3900

**Panbasic AIRtec Tee** P-903

**Gildan Performance** 4B100 / 4B100B

**Crossrunner Performance Tee** CRR 3600B / CRR 36400

**Crossrunner Athletic Tee** CRR 1100 / CRR 1200 / CRR 1300

**Crossrunner Sublimated Jersey** CRR 1800

CRR 1900 / CRR 2000 / CRR 2100 / CRR 2200 / CRR 2300

**Crossrunner Singlet** CRV 1300 / CRV 1600 / CRV1700

**Crossrunner Tracksuit** CRT 1200J

**Track Pants** CRT 1100P / CRS 1100 / P-501 / P-502

**Crossrunner Basketball Suit** CRB 1100







## 127 · OUTERWEAR

### North Harbour Jacket

NHJ 1100 / NHJ 2100

### Gildan Heavy Blend

88000 / 88500 / 88600 / 18700 / 18800

### Crossrunner Jacket

CRJ 1100 / CRJ 1200



## PREMIUM WORKWEAR · 145

### North Harbour Dress Shirt

NHB 1400 / NHB 1500 / NHB 2000

### North Harbour Corporate Imagewear

NHB 1700 / NHB 1800 / NHB 1900  
NHB 2600 / NHB 3000

### North Harbour Denim Shirts

NHB 3100

### North Harbour Charm Shirts

NHB 3400

## 163 · ETHNIC WEAR

### Sarra Fashion Collection

SMW 1300 / SMW 1300M / SMW 1500

SMW 1500M / SMW 1600

Sarra Sporty Muslimah SMW 1800

Sarra Denim Muslimah SMW 1900



## HOMWEAR & ACCESSORIES · 171

North Harbour Baseball Cap NHC 1100

North Harbour Snapback NHC 1200

North Harbour Towel NHT 1100 / NHT 2100

Montex Anti-bacterial Towel

North Harbour Apron NHA 1100

Crossrunner Eco Face Mask CRM 1100 / CRM 1200



NORTH HARBOUR



## Adult Crew Neck T-Shirt - NHR 1100

160 g/m<sup>2</sup> (4.7 oz/yd<sup>2</sup>)  
 100% ring spun cotton preshrunk jersey knit  
 Fiber content varies by color, see color list for details  
 2cm rib collar  
 Tubular construction  
 Taped neck and shoulders  
 Double needle sleeve and bottom hems  
 Tear away label  
 18 colors  
 Sizes : XS - 3XL  
 RRP : 24.90 MYR / 9.90 SGD

Size	XS	S	M	L	XL	2XL	3XL
Width	46	48	51	53	56	58	60
Length	66	68	70	72	74	76	78

Measurements may vary +/- 5% from actual product  
 Measurements are presented in cm

## 18 colors

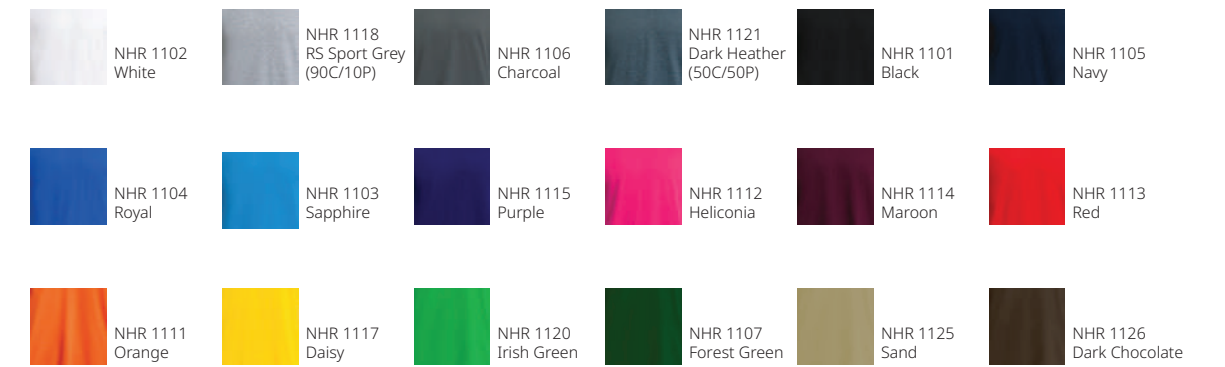

T-shirts may be simple, but with the right colour and styling tricks, you can turn something simple into a statement piece! A basic item that goes with any look.



# NHR 11400 LONG SLEEVE T-SHIRT



NORTH HARBOUR



NHR 11402  
White



NHR 11418  
RS Sport Grey  
(90C/10P)



NHR 11401  
Black



NHR 11405  
Navy



NHR 11404  
Royal



NHR 11413  
Red



NHR 11420  
Irish Green

## Adult Long Sleeve T-Shirt

160 g/m<sup>2</sup> (4.7 oz/yd<sup>2</sup>)

100% ring spun cotton preshrunk jersey knit

Fiber content varies by color, see color list for details

2cm rib collar

Tubular construction

Taped neck and shoulders

Double needle sleeve and bottom hems

Tear away label

7 colors

Sizes : S - 3XL

RRP : 27.90 MYR / 11.90 SGD

Size	S	M	L	XL	2XL	3XL
Width	48	51	53	56	58	60
Length	68	70	72	74	76	78

Measurements may vary +/- 5% from actual product  
Measurements are presented in cm

NORTH HARBOUR



# NHR 1100B YOUTH T-SHIRT

## Youth Crew Neck T-Shirt

160 g/m<sup>2</sup> (4.7 oz/yd<sup>2</sup>)

100% ring spun cotton preshrunk jersey knit

Fiber content varies by color, see color list for details

1.5cm rib collar

Sideseamed

Taped neck and shoulders

Double needle sleeve and bottom hems

Tear away label

7 colors

Sizes : YXS / YM / YXL

RRP : 24.90 MYR / 10.90 SGD

Size	YXS	YM	YXL
Width	30	35	41
Length	37	49	58

Measurements may vary +/- 5% from actual product  
Measurements are presented in cm



NHR 1102B  
White



NHR 1118B  
RS Sport Grey  
(90C/10P)



NHR 1101B  
Black



NHR 1105B  
Navy



NHR 1104B  
Royal



NHR 1113B  
Red



NHR 1120B  
Irish Green







NORTH HARBOUR

Tetron cotton single jersey  
 Round neckline, solid-toned tee  
 Extreme soft handfeel  
 Durable and breathable  
 Long lasting color  
 Anti-collapse, opaque  
 Anti-pilling and wrinkle-resistant  
 Double-needle sleeve and bottom hems  
 Tear away label

**NHO 1100**  
**Dynamite Oversized**  
**Crew Neck T-Shirt**

A fashionable half-sleeve T-shirt in an oversized cut for a relaxed feel.



Sizes : S - 2XL  
 RRP : 35.90 MYR / 14.90 SGD

Size	S	M	L	XL	2XL
Width	54	57	60	64	68
Length	66	69	75	76	78

Measurements may vary +/- 5% from actual product  
 Measurements are presented in cm

 NHO 1101 Black	 NHO 1102 Sport Grey	 NHO 1103 Navy
 NHO 1104 Bright Rose	 NHO 1105 Sand	 NHO 1106 Elderberry
 NHO 1107 Tan	 NHO 1108 Basil	







## 63000 Adult T-Shirt

150 g/m<sup>2</sup> (4.5 oz/yd<sup>2</sup>)  
 100% ring spun cotton preshrunk jersey knit  
 Fiber content varies by color, see color list for details  
 Taped neck and shoulders  
 Double needle sleeve and bottom hems  
 Quarter-turned to eliminate center crease  
 2 cm rib collar  
 Tear away label  
 21 colors

Sizes : XS - 2XL  
 RRP : 25.90 MYR / 10.90 SGD

Size	XS	S	M	L	XL	2XL
Width	44	47	50	53	56	59
Length	64	67	70	73	75	77

Measurements may vary +/- 5% from actual product  
 Measurements are presented in cm



 30 N White	 191 C Orchid	 20 C Light Pink
 10 C Heliconia	 83 C Maroon	 40 C Red
 37 C Orange	 98 C Daisy	 475 C Corn silk
 12 C Lime	 167 C Irish Green	 32 C Navy
 26 C Sapphire	 51 C Royal	 109 C Carolina Blue
 69 C Light Blue	 81 C Purple	 42 C Charcoal
 295 H RS Sport Grey *(90C/10P)	 516 H Graphite Heather *(50C/50P)	 36 C Black





## 63V00 Adult V-Neck T-Shirt

150 g/m<sup>2</sup> (4.5 oz/yd<sup>2</sup>)  
 100% ring spun cotton preshrunk jersey knit  
 Fiber content varies by color, see color list for details  
 1.5 cm mitered v-neck collar  
 Taped neck and shoulders  
 Double needle sleeve and bottom hems  
 Quarter-turned to eliminate center crease  
 Tear away label  
 5 colors  
 Sizes : XS - 2XL  
 RRP : 35.90 MYR / 14.90 SGD

Size	XS	S	M	L	XL	2XL
Width	44	47	50	53	56	59
Length	64	67	70	73	75	77

Measurements may vary +/- 5% from actual product  
 Measurements are presented in cm







**GILDAN**  
Softstyle®

OEKO-TEX®  
CONFIDENCE IN TEXTILES  
**STANDARD 100**  
68255 OeT1  
Tested for harmful substances  
www.oeko-tex.com/standard100

## 63V00L Ladies V-Neck T-Shirt

150 g/m<sup>2</sup> (4.5 oz/yd<sup>2</sup>)  
 100% ring spun cotton preshrunk jersey knit  
 Fiber content varies by color, see color list for details  
 Semi-fitted contoured silhouette with side seam  
 1.5 cm mitered v-neck collar  
 Taped neck and shoulders  
 Double needle sleeve and bottom hems  
 Tear away label  
 6 colors  
 Sizes : LS - LXL  
 RRP : 35.90 MYR / 14.90 SGD

Size	LS	LM	LL	LXL
Width	41	43	46	49
Length	59	61	64	66

Measurements may vary +/- 5% from actual product  
 Measurements are presented in cm



-   
30 N  
White
-   
295 H  
RS Sport Grey  
\*(90C/10P)
-   
36 C  
Black
-   
32 C  
Navy
-   
40 C  
Red
-   
10 C  
Heliconia





## 76000 Adult T-Shirt

180 g/m<sup>2</sup> (5.3 oz/yd<sup>2</sup>)  
 100% ring spun cotton preshrunk jersey knit  
 Fiber content varies by color, see color list for details  
 2 cm rib collar  
 Taped neck and shoulders  
 Double needle sleeve and bottom hems  
 Quarter-turned to eliminate center crease  
 Satin label  
 36 colors  
 XS - 5XL (Black, Navy, Red, RS Sport Grey, White)  
 XS - 3XL (All the rest colors)  
 RRP: 29.90 MYR / 11.90 SGD



Size	XS	S	M	L	XL	2XL	3XL	4XL	5XL
Width	44	47	50	53	56	59	63	66	71
Length	64	67	70	73	75	77	80	83	86

Measurements may vary +/- 5% from actual product  
 Measurements are presented in cm



20 C Light Pink	38 C Sand	188 C Safety Green (50C/50P)	029 C Jade Dome	69 C Light Blue	30 N White
71 C Azalea	98 C Daisy	12 C Lime	218 C Heather Royal (50C/50P)	109 C Carolina Blue	93 H Ash Grey (99C/1P)
263 C Safety Pink (50C/50P)	24 C Gold	215 C Heather Irish Green (50C/50P)	51 C Royal	26 C Sapphire	295 H RS Sport Grey (90C/10P)
10 C Heliconia	193 C Safety Orange (50C/50P)	167 C Irish Green	445 C Cobalt	81 C Purple	42 C Charcoal
234 C Heather Red (50C/50P)	37 C Orange	106 C Military Green	765 C Sport Royal (50C/50P)	232 C Heather Purple (50C/50P)	108 C Dark Heather (50C/50P)
83 C Maroon	40 C Red	33 C Forest Green	32 C Navy	105 C Dark Chocolate	36 C Black





## 76000L LADIES T-SHIRT

180 g/m<sup>2</sup> (5.3 oz/yd<sup>2</sup>)  
100% ring spun cotton preshrunk jersey knit  
Fiber content varies by color  
Semi-fitted contoured silhouette with side seam  
1.3 cm rib collar  
Taped neck and shoulders  
Double needle sleeve and bottom hems  
Satin Label  
22 colors  
Sizes : LS - LXL  
RRP : 29.90 MYR / 11.90 SGD



Size	LS	LM	LL	LXL
Width	41	43	46	49
Length	59	61	64	66

Measurements may vary +/- 5% from actual product  
Measurements are presented in cm



## BASIC FOR HER

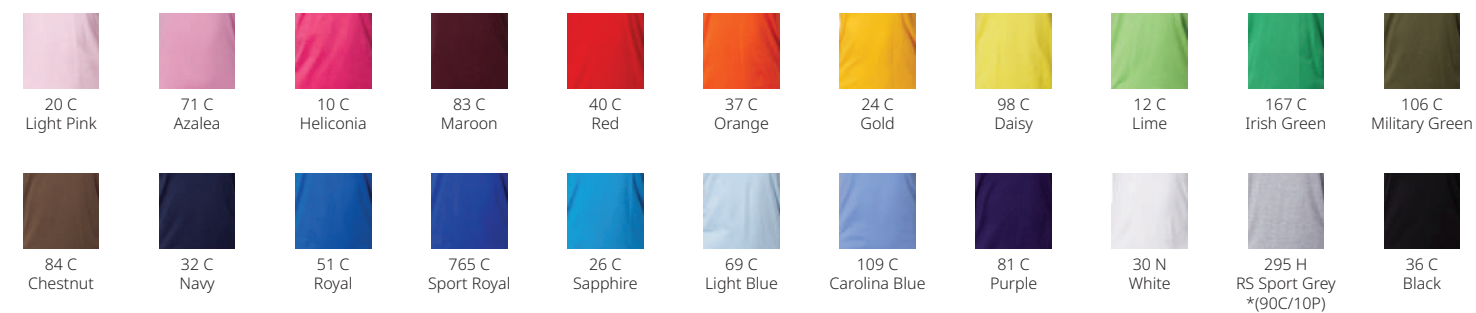



# ADORABLE YET COMFORTABLE

make children's everyday better



Fun t-shirts for boys & girls, ideal for every occasion; comfort to complete any outfit for more relaxed days.

## 76000B Youth T-Shirt

180 g/m<sup>2</sup> (5.3 oz/yd<sup>2</sup>)  
 100% ring spun cotton preshrunk jersey knit  
 Fiber content varies by color, see color list for details  
 1.5 cm rib collar  
 Sideseamed  
 Taped neck and shoulders  
 Double needle sleeve and bottom hems  
 CPSIA tracking label compliant  
 Satin Label  
 20 colors  
 Sizes : YXS - YXL  
 RRP : 26.90 MYR / 10.90 SGD

Size	YXS	YS	YM	YL	YXL
Width	33	36	38	41	43
Length	45	48	51	54	58

Measurements may vary +/- 5% from actual product  
 Measurements are presented in cm







## Heavyweight Adult T-Shirt - HA00

210 g/m<sup>2</sup> (6.1 oz/yd<sup>2</sup>)  
 100% combed ring spun cotton preshrunk jersey knit  
 High stitch density for smoother printing surface  
 Classic Fit  
 2.3 cm rib collar  
 Taped neck and shoulders  
 2 cm double-needle sleeve and bottom hems  
 Quarter-turned to eliminate center crease  
 Tear away label  
 XS - 3XL (White, Black, Navy, Red, RS Sport Grey)  
 XS - 2XL (All the rest colors)  
 RRP : 34.90 MYR / 13.90 SGD

Size	XS	S	M	L	XL	2XL
Width	44	47	50	53	56	59
Length	64	67	70	73	75	77

Measurements may vary +/- 5% from actual product  
 Measurements are presented in cm

## 16 colors



Perfect for active types! A heavyweight T-shirt with a slightly fitted look.  
 Fiber content varies by color, see color list for details





## ADULT T-SHIRT WITH POCKET - HA30

210 g/m<sup>2</sup> (6.1 oz/yd<sup>2</sup>)  
 100% combed ring spun cotton preshrunk jersey knit  
 Fiber content varies by color, see color list for details  
 High stitch density for smoother printing surface  
 2 cm double needle pocket, sleeve and bottom hems  
 Quarter-turned to eliminate center crease  
 Single needle left chest set pocket

Taped neck and shoulders  
 Classic Fit  
 2.3 cm rib collar  
 Tear away label  
 4 colors  
 Sizes : XS - 2XL  
 RRP : 32.90 MYR / 13.90 SGD

Size	XS	S	M	L	XL	2XL
Width	44	47	50	53	56	59
Length	64	67	70	73	75	77

Measurements may vary +/- 5% from actual product  
 Measurements are presented in cm

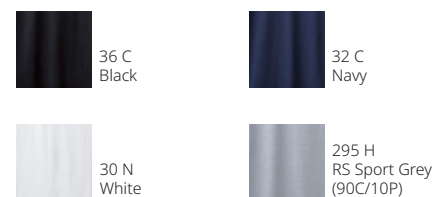

## P-901 Adult Round Neck T-Shirt

Lightweight and breathable T-shirt that will keep you feeling cool and comfortable all day. Perfect for the summer and hot weather. 100% cotton fabrics provide a soft, natural fabric that is fully breathable.



100% ring-spun cotton preshrunk jersey knit  
 1.3 cm rib collar  
 Fiber content varies by color  
 Tape neck and shoulders  
 Quarter-turned to eliminate center crease  
 Double-needle sleeve and bottom hems  
 Adult Unisex  
 Material : 100% Premium Cotton  
 Fabric : Jersey Knit  
 Weight: 160 Grams  
 Size : XS – 7XL  
 RRP : 24.90 MYR / 10.90 SGD



Size	XS	S	M	L	XL	2XL	3XL	5XL	7XL
Width	46	48	51	53	56	58	61	66	71
Length	63	66	68	71	73	76	79	86	91

Measurements may vary +/- 5% from actual product  
 Measurements are presented in cm





**GILDAN**  
PREMIUM  
Cotton™

OEKO-TEX®  
CONFIDENCE IN TEXTILES  
STANDARD 100  
68255 OeTI  
Tested for harmful substances  
www.oeko-tex.com/standard100

## 5 colors



Size	S	M	L	XL	2XL
Width	47	50	53	56	59
Length	66	69	72	74	76

Measurements may vary +/- 5% from actual product  
Measurements are presented in cm



## ADULT LONG SLEEVE T-SHIRT - 76400

180 g/m<sup>2</sup> (5.3 oz/yd<sup>2</sup>)  
100% ring spun cotton preshrunk jersey knit  
Fiber content varies by color  
2 cm rib collar  
Taped neck and shoulders  
Double needle sleeve and bottom hems  
Quarter-turned to eliminate center crease  
5 colors  
Satin Label  
Sizes : S - 2XL  
RRP : 32.90 MYR / 13.90 SGD



## 76600 Adult Ringer T-Shirt

180 g/m<sup>2</sup> (5.3 oz/yd<sup>2</sup>)  
 100% ring spun cotton preshrunk jersey knit  
 Fiber content varies by color  
 Double needle bottom hem  
 Contrast neck and sleeve bands  
 Quarter-turned to eliminate center crease  
 Satin Label  
 7 colors combinations  
 Sizes : XS -2XL  
 RRP : 32.90 MYR / 13.90 SGD

Size	XS	S	M	L	XL	2XL
Width	44	47	50	53	56	59
Length	64	67	70	73	75	77

Measurements may vary +/- 5% from actual product  
 Measurements are presented in cm



## 76700 - ADULT RAGLAN T-SHIRT

### 3/4 SLEEVE

180 g/m<sup>2</sup> (5.3 oz/yd<sup>2</sup>)  
 100% ring spun cotton preshrunk jersey knit  
 Contrast color set-in collar  
 Single needle top stitching at back neck  
 Double needle sleeve and bottom hems  
 Quarter-turned to eliminate center crease  
 5 colors combinations  
 Satin Label  
 Sizes : S - 2XL  
 RRP : 39.90 MYR / 16.90 SGD



Size	S	M	L	XL	2XL
Width	47	50	53	56	59
Length	67	70	73	75	77

Measurements may vary +/- 5% from actual product  
 Measurements are presented in cm







## 7 colors



FC 030  
White / Red



FH 030  
White /  
Irish Green



FE 030  
White / Royal



GN 030  
White /  
Heather Royal



FB 030  
White / Black



FS 036  
Black / White



FB 295  
RS Sport Grey\*/ Black  
(90C/10P)

OEKO-TEX®  
CONFIDENCE IN TEXTILES  
STANDARD 100  
08/2015 ON-11  
Tested for harmful substances  
www.oeko-tex.com/standard100



## 76500 Adult Raglan T-Shirt

180 g/m<sup>2</sup> (5.3 oz/yd<sup>2</sup>)  
100% ring spun cotton preshrunk jersey knit  
Fiber content varies by color  
Raglan short sleeves  
Contrast color 2 cm seamed collar  
Double needle sleeve and bottom hems  
Quarter-turned to eliminate center crease  
Satin Label  
Sizes : S -2XL  
RRP : 32.90 MYR / 13.90 SGD

Size	S	M	L	XL	2XL
Width	47	50	53	56	59
Length	67	70	73	75	77

Measurements may vary +/- 5% from actual product  
Measurements are presented in cm





# ULTRA COTTON

simple made better



**GILDAN**  
Ultra Cotton

OEKO-TEX®  
CONFIDENCE IN TEXTILES  
**STANDARD 100**  
68325 Oe11  
Tested for harmful substances  
www.oeko-tex.com/standard100

## 13 colors



## 2000 Adult T-Shirt

203 g/m<sup>2</sup> (6.0 oz/yd<sup>2</sup>)  
 100% cotton preshrunk jersey knit  
 Fiber content varies by color, see color list for details  
 Quarter-turned to eliminate center crease  
 Tear away label  
 Seamless double-needle 2.2 cm collar  
 Taped neck and shoulders  
 Double needle sleeve and bottom hems  
 S - 2XL (Heather Series)  
 S - 3XL (Red, Charcoal, Royal, Military Green)  
 S - 5XL (White, Black, Navy, Sport Grey)  
 RRP : 34.90 MYR / 13.90 SGD





Size	S	M	L	XL	2XL	3XL	4XL	5XL
Width	45	51	56	61	66	71	76	81
Length	71	73	76	78	81	84	86	89

Measurements may vary +/- 5% from actual product  
 Measurements are presented in cm





-  30 N White
-  295 H RS Sport Grey (90C/10P)
-  36 C Black
-  32 C Navy
-  11 C Cardinal Red
-  83 C Maroon

Size	S	M	L	XL	2XL
Width	45	51	56	61	66
Length	71	73	76	78	81

Measurements may vary +/- 5% from actual product  
Measurements are presented in cm





## 2400 - Adult Long Sleeve T-Shirt

203 g/m<sup>2</sup> (6.0 oz/yd<sup>2</sup>)  
 100% cotton preshrunk jersey knit  
 Fiber content varies by color  
 Seamless double-needle 2.2 cm collar  
 Rib cuffs  
 Double-needle bottom hem  
 Taped neck and shoulders  
 Quarter-turned to eliminate center crease  
 Tear away label  
 Sizes : S - 2XL  
 RRP : 39.90 MYR / 16.90 SGD







-  32 C  
Navy
-  295 H  
RS Sport Grey  
\*(90C/10P)
-  36 C  
Black



## 2200 ADULT TANK TOP





203 g/m<sup>2</sup> (6. oz/yd<sup>2</sup>)  
 Preshrunk jersey knit  
 Fiber content varies by color  
 Banded neck and armholes  
 Double-needle bottom hem  
 Quarter-turned to eliminate center crease  
 Tear away label  
 Classic Fit  
 Sizes : S - XL  
 RRP : 29.90 MYR / 11.90 SGD

Size	S	M	L	XL
Width	45	51	56	61
Length	71	73	76	78

Measurements may vary +/- 5% from actual product  
 Measurements are presented in cm





-  286 C  
Midnight
-  274 C  
Russet
-  284 C  
Lilac
-  276 C  
Tweed
-  516 C  
Graphite Heather



# 5000 Adult T-Shirt

## Heavy Cotton

180 g/m<sup>2</sup> (5.3 oz/yd<sup>2</sup>)  
 50% Cotton 50% Polyester  
 Preshrunk jersey knit  
 Classic Fit  
 Fiber content varies by color, see color list for details  
 Seamless double-needle 2cm collar  
 Quarter-turned to eliminate center crease  
 Taped neck and shoulders  
 Double needle sleeve and bottom hems  
 Tear away label  
 Sizes : S - 2XL  
 RRP : 34.90 MYR / 13.90 SGD

### Size Chart

Size	S	M	L	XL	2XL
Width	45	51	56	61	66
Length	71	73	76	78	81

Measurements may vary +/- 5% from actual product  
 Measurements are presented in cm





# COMFORT COLORS®



210 g/m<sup>2</sup> (6.1 oz/yd<sup>2</sup>)  
 100% ring spun cotton  
 Soft washed garment dyed fabric  
 Double needle collar  
 Twill taped neck and shoulders  
 Twill label Joker label  
 Double needle armhole, sleeve and bottom hems  
 Sizes : S - XL  
 RRP : 72.90 MYR / 28.90 SGD

Size	S	M	L	XL
Width	47	52	57	62
Length	68	72	76	80

Measurements may vary +/- 5% from actual product  
 Measurements are presented in cm



## 1717 Adult T-Shirt







# 2001W Crewneck T-Shirt

## FINE JERSEY

146 g/m<sup>2</sup> (4.3 oz/yd<sup>2</sup>)  
 100% combed ringspun cotton  
 Incredibly soft  
 Medium-weight fabric  
 Classic Fit  
 2cm seamed collar  
 Shoulder-to-shoulder taping  
 1" double-needle sleeve and bottom hems  
 Double-satin razor label  
 Sizes : S - XL  
 RRP : 69.90 MYR / 27.90 SGD

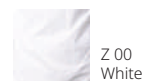

Z 00  
White



Z 36  
Black



Z 30  
Grass

Size	S	M	L	XL
Width	45	51	56	61
Length	73	75	78	80

Measurements may vary +/- 5% from actual product  
 Measurements are presented in cm



**American Apparel**





## 7 colors



Size	XS	S	M	L	XL	2XL
Width	45	47	49	52	55	58
Length	64	66	68	71	74	77

Measurements may vary +/- 5% from actual product  
Measurements are presented in cm



## MAINE Men's Crew Neck T-shirt

180 g/m<sup>2</sup> (5.3 oz/yd<sup>2</sup>)  
100% Premium Ring Spun Cotton  
Pre-Shrunk Fine Jersey Knit  
Contemporary Retail Fit, Side-Seamed  
Rolled Forward Shoulder, Fitted  
Shoulder to Shoulder Neck Taping  
1.5cm Low Profile Elastane Neck Rib  
Double Needle Sleeve & Bottom Hems  
Tear Away Labels  
Sizes : XS - 2XL  
RRP : 32.90 MYR / 13.90 SGD





Size	XS	S	M	L	XL	2XL
Width	45	47	49	52	55	58
Length	64	66	68	71	74	77

Measurements may vary +/- 5% from actual product  
Measurements are presented in cm

 **STATESIDE™**

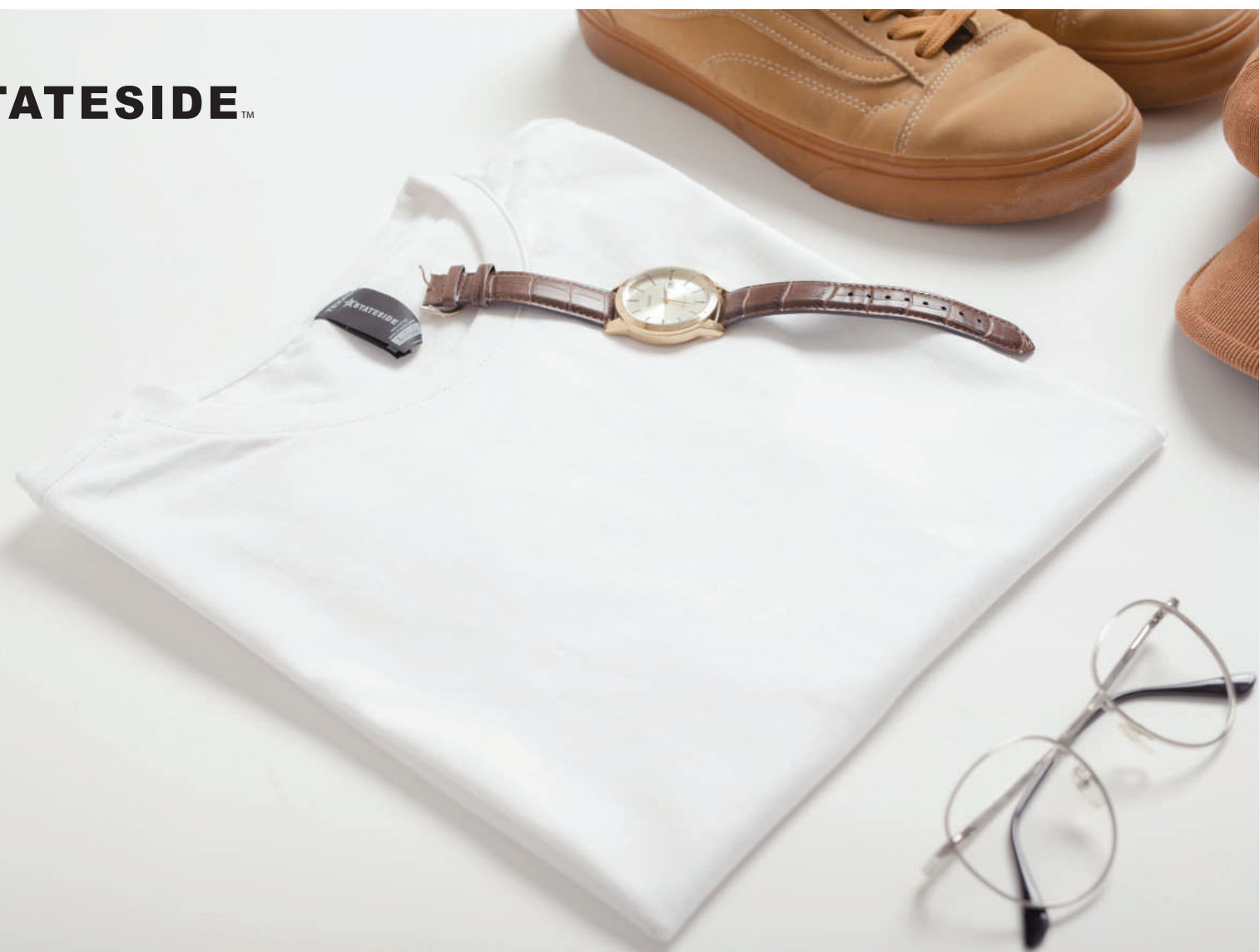

## TEXAS Men's Crew Neck T-shirt

205 g/m<sup>2</sup> (6.1 oz/yd<sup>2</sup>)  
100% Premium Ring Spun Cotton  
Pre-Shrunk Fine Jersey Knit  
Contemporary Fashion Fit, Side-Seamed  
Rolled Forward Shoulder, Fitted  
Shoulder to Shoulder Neck Taping  
1.5cm Low Profile Elastane Neck Rib  
Double Needle Sleeve & Bottom Hems  
Tear Away Labels  
Sizes : XS - 2XL  
RRP : 37.90 MYR / 15.90 SGD



### 7 colors





ANVIL®  
BY GILDAN



## Adult Midweight Camouflage Tee - 939

From the newest looks to fresh takes on classic styles, ANVIL® by Gildan® tees have all the bases covered. Featuring a high stitch density, they deliver amazing long-lasting comfort in a package that's ideal for direct-to-garment printing.



170 g/m<sup>2</sup> (4.9 oz/yd<sup>2</sup>)  
Preshrunk jersey knit  
100% Cotton, Ring Spun  
Fabric 26/1  
Classic Fit  
Side seam construction  
Shoulder-to-shoulder tape and seamed collar  
Twin-needle neck, sleeve and bottom hem  
Oeko-Tex® Standard 100 Certified  
Tear away label  
Sizes : S - 2XL  
RRP : 39.90 MYR / 16.90 SGD



ANV 9391  
Camouflage Green

ANV 9392  
Camouflage Sand

Size	S	M	L	XL	2XL
Width	45	51	56	60	66
Length	71	73	76	78	81

Measurements may vary +/- 5% from actual product  
Measurements are presented in cm



ANVIL<sup>®</sup>  
BY GILDAN

# 6755 3/4 SLEEVE RAGLAN TEE

## Adult Tri-Blend

160 g/m<sup>2</sup> (4.7 oz/yd<sup>2</sup>)  
Preshrunk jersey knit  
50% polyester / 25% combed ring spun cotton / 25% rayon  
Fabric 30/1  
Semi-fitted  
Side seam construction  
Contrast colour set-in collar and 3/4 raglan sleeve  
Single-needle topstitched back neck  
Double-needle sleeve and bottom hems  
High stitch density for smoother printing surface  
Wicking properties  
Oeko-Tex® Standard 100 Certified  
Tear away label  
5 colors  
Sizes : XS - XL  
RRP : 39.90 MYR / 16.90 SGD



Size	XS	S	M	L	XL
Width	40	45	51	56	60
Length	66	68	71	73	76

Measurements may vary +/- 5% from actual product  
Measurements are presented in cm



Size	S	M	L	XL
Width	45	51	56	60
Length	68	71	73	78

Measurements may vary +/- 5% from actual product  
Measurements are presented in cm

# 980 Adult Lightweight Tee

150 g/m<sup>2</sup> (4.5 oz/yd<sup>2</sup>)  
Pre-shrunk 100% combed ring spun cotton  
Tubular construction  
Fabric 30/1  
Semi-Fitted  
High stitch density for smoother printing surface  
Shoulder-to-shoulder tape and seamed collar  
Twin-needle sleeve and bottom hems  
Oeko-Tex® Standard 100 Certified  
Tear away label  
Sizes : S - XL  
RRP : 39.90 MYR / 16.90 SGD







ANVIL<sup>®</sup>  
BY GILDAN

150 g/m<sup>2</sup> (4.5 oz/yd<sup>2</sup>)  
Preshrunk jersey knit  
100% Cotton, Combed Ring Spun  
Fabric 30/1 Semi-Fitted  
Twin-needle neck, sleeve and bottom hem  
Tubular construction  
Display tape  
Relaxed unlined hood with contrast drawcord  
Tear away label

**Adult Lightweight  
Long Sleeve  
Hooded Tee - 987**





Oeko-Tex® Standard 100 Certified  
High stitch density for smoother printing surface



Sizes : S - XL  
RRP : 39.90 MYR / 16.90 SGD

Size	S	M	L	XL
Width	45	51	56	61
Length	70	73	76	78

Measurements may vary +/- 5% from actual product  
Measurements are presented in cm

 ANV 308 Caribbean Blue	 ANV 032 Navy
 ANV 334 Heather Dark Grey (35C/65P)	 ANV 036 Black







**NORTH HARBOUR**

Equal parts of professional and casual.  
North Harbour are designed to be just as  
comfortable for modern lifestyle.  
Polo shirt bridges the gap between smart and  
casual perfectly.







**NORTH HARBOUR**

**NHB 2400  
SOFT-TOUCH POLO**

60% Cotton 40% Polyester Lacoste  
 Ribbed polo collar  
 Three-button placket  
 Short sleeves with ribbed armbands  
 Double-needle bottom hem  
 Laser engraved buttons  
 Fiber content varies by color, see color list for details  
 Classic Fit  
 Woven Label  
 23 colors  
 Sizes : XS - 3XL  
 RRP : 49.90 MYR / 19.90 SGD



**23 colors**

 NHB 2402 White	 NHB 2412 Heliconia	 NHB 2414 Maroon	 NHB 2413 Red	 NHB 2411 Orange	 NHB 2423 Vegas Gold
 NHB 2417 Daisy	 NHB 2416 Lime	 NHB 2420 Irish Green	 NHB 2407 Forest Green	 NHB 2419 Jade dome	 NHB 2425 Tiffany Blue
 NHB 2403 Sapphire	 NHB 2424 Sky	 NHB 2426 Violet	 NHB 2404 Royal	 NHB 2415 Purple	 NHB 2405 Navy
 NHB 2418 Sport Grey	 NHB 2422 Ice Grey	 NHB 2406 Charcoal	 NHB 2421 Dark Heather	 NHB 2401 Black	

Size	XS	S	M	L	XL	2XL	3XL
Width	46	48	51	53	56	58	61
Length	66	68	71	73	76	79	81

Measurements may vary +/- 5% from actual product  
 Measurements are presented in cm





# NHB 24400

LONG SLEEVE SOFT-TOUCH POLO



NORTH HARBOUR

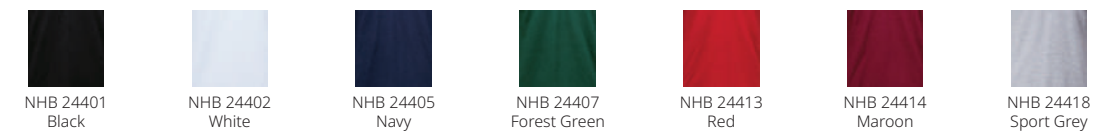

60% Cotton 40% Polyester Lacoste  
 Ribbed polo collar  
 Three-button placket  
 Fiber content varies by color, see color list for details  
 Long sleeves with ribbed cuffs  
 Double-needle bottom hem

Laser engraved buttons  
 Classic Fit  
 Woven Label  
 7 colors  
 Sizes : XS - 3XL  
 RRP : 49.90 MYR / 19.90 SGD

Size	XS	S	M	L	XL	2XL	3XL
Width	46	48	51	53	56	58	61
Length	66	68	71	73	76	79	81

Measurements may vary +/- 5% from actual product  
 Measurements are presented in cm





**GILDAN**  
PREMIUM  
Cotton™

## 6800 - Adult Cotton Double Pique Sport Shirt

220 g/m<sup>2</sup> (6.5 oz/yd<sup>2</sup>)  
100% cotton  
Sideseamed with side vents  
Contoured welt collar and cuffs  
Rolled forward topstitched shoulder  
Clean finished placket with reinforced bottom box  
3 color-matched buttons  
Double needle bottom hem  
Tear away label  
10 colors  
Sizes : XS - 2XL  
RRP : 34.90 MYR / 15.90 SGD

Size	XS	S	M	L	XL	2XL
Width	43	46	49	52	55	59
Length	62	65	68	71	75	79

Measurements may vary +/- 5% from actual product  
Measurements are presented in cm



## NHB 2100 GEORGIA POLO

A polo shirt that has both great functionality and design. Looks stylish, while keeping you comfortable. Its gives a modern, athletic look. The fabric is breathable, and easy to coordinate with any pair of pants. you'll be worry free and ready to face the day.



NORTH HARBOUR

65% Cotton 35% Polyester Lacoste  
Ribbed polo collar  
Pearlized buttons  
Short sleeves with ribbed armbands  
Double-needle bottom hem  
Bold diagonal panel design  
Woven label  
Sizes : S - 3XL  
RRP : 49.90 MYR / 19.90 SGD



Size	S	M	L	XL	2XL	3XL
Width	48	51	53	56	58	61
Length	68	71	73	76	79	81

Measurements may vary +/- 5% from actual product  
Measurements are presented in cm



# YORK POLO - NHB 2200

Mandarin collar short sleeves polo with contrasting ribbed trim.



NHB 2201  
Black / Gold



NHB 2202  
Red / Black



NHB 2203  
Navy / Red



NHB 2204  
Charcoal / Royal



NHB 2205  
Royal / Sapphire



NHB 2206  
Sport Grey / Navy, Red

65% Cotton 35% Polyester Lacoste  
Sleek tipping collar design  
Front button closure  
Pearlized buttons  
Short sleeves with ribbed armbands  
Casual, meet smart

Double-needle bottom hem  
Side vents at hem  
Regular fit  
Woven Label  
Sizes : S - 3XL  
RRP : 49.90 MYR / 19.90 SGD

Size	S	M	L	XL	2XL	3XL
Width	48	51	53	56	58	61
Length	68	71	73	76	79	81

Measurements may vary +/- 5% from actual product  
Measurements are presented in cm

## NHB 2300 MURPHY POLO

65% Cotton 35% Polyester Lacoste  
Ribbed polo collar  
Pearlized buttons  
Bold color matching sleeve  
Short sleeves with ribbed armbands  
Double-needle bottom hem  
Side vents at hem  
Woven Label  
Sizes : S - 3XL  
RRP : 49.90 MYR / 19.90 SGD

Size	S	M	L	XL	2XL	3XL
Width	48	51	53	56	58	61
Length	68	71	73	76	79	81

Measurements may vary +/- 5% from actual product  
Measurements are presented in cm



NHB 2301  
White  
Red / Navy



NHB 2302  
Navy  
White / Red



NHB 2303  
Red  
White / Black



NHB 2304  
Royal  
Charcoal / Navy



NHB 2305  
Sapphire  
Navy / White



NHB 2306  
Navy  
Forest Green / Royal



NHB 2307  
Forest Green  
Charcoal / Black



NHB 2308  
Sport Grey  
Black / Daisy



NORTH HARBOUR



# NHB 2500 MULLER POLO

## Smart Casual

65% Cotton 35% Polyester Lacoste  
Knitted tipping collar and placket  
Stripes on front placket  
Pearlized buttons  
Contrast color shoulder panel  
Double-needle sleeve and bottom hems  
Side vents at hem  
Woven Label  
Sizes : S - 3XL  
RRP : 49.90 MYR / 19.90 SGD



NHB 2501  
Navy / Sapphire



NHB 2502  
Royal / Navy



NHB 2503  
Red / Navy



NHB 2504  
Black / Daisy

Size	S	M	L	XL	2XL	3XL
Width	48	51	53	56	58	61
Length	68	71	73	76	79	81

Measurements may vary +/- 5% from actual product  
Measurements are presented in cm



NORTH HARBOUR

# NHB 2800 GLANCE POLO

65% Cotton 35% Polyester Lacoste  
Double layer woven collar  
Pearlized buttons  
Short sleeves with ribbed armbands  
Double-needle bottom hem  
Side vents at hem  
Casual, meet smart  
Regular fit  
Woven Label  
Sizes : S - 3XL  
RRP : 49.90 MYR / 19.90 SGD

Size	S	M	L	XL	2XL	3XL
Width	48	51	53	56	58	61
Length	68	71	73	76	79	81

Measurements may vary +/- 5% from actual product  
Measurements are presented in cm



NHB 2801  
White /  
Light blue



NHB 2802  
Red /  
Charcoal



NHB 2803  
Royal /  
Charcoal



NHB 2804  
Navy /  
Charcoal



NHB 2805  
Black /  
Light Blue

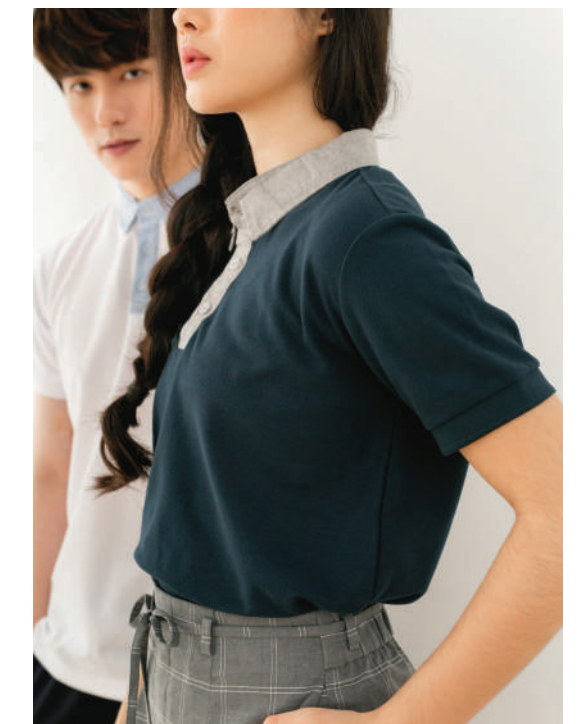



**NORTH HARBOUR**



65% Cotton 35% Polyester Lacoste  
 Knitted tipping collar & cuffs  
 Pearlized buttons  
 Double-needle bottom hem  
 Side vents at hem  
 Casual, meet smart  
 Woven Label  
 Sizes : S - 3XL  
 RRP : 49.90 MYR / 19.90 SGD

Size	S	M	L	XL	2XL	3XL
Width	48	51	53	56	58	61
Length	68	71	73	76	79	81

Measurements may vary +/- 5% from actual product  
 Measurements are presented in cm



**NHB 2700 - Saffron Polo**



NHB 2709 Maroon White / Navy  
 NHB 2702 Red White / Black  
 NHB 2707 Daisy White / Black  
 NHB 2708 Forest Green White / Daisy  
 NHB 2705 Navy Red / White  
 NHB 2704 Royal White / Navy  
 NHB 2703 Sapphire White / Navy  
 NHB 2710 Purple White / Black  
 NHB 2701 White Red / Black  
 NHB 2706 Black White / Red  
 NHB 2711 Sport Grey Downy / Sumr. Sky





NHB 2901  
Maroon /  
Charcoal / White



NHB 2902  
Royal /  
Charcoal / White



NHB 2903  
Forest Green /  
Charcoal / White



NHB 2904  
Navy /  
Royal / White



NHB 2905  
Navy /  
Forest Green / White



# NHB 2900 ADLEY POLO

## Classic Fit

65% Cotton 35% Polyester Lacoste  
V shape sliding design across sleeves  
Ribbed Polo collar  
Pearlized buttons  
Three-button placket  
Short sleeves with ribbed armbands  
Double-needle bottom hem  
Side vents at hem  
Casual, meet smart  
Woven Label  
Sizes : S - 3XL  
RRP : 59.90 MYR / 23.90 SGD

## Size Chart

Size	S	M	L	XL	2XL	3XL
Width	48	51	53	56	58	61
Length	68	71	73	76	79	81

Measurements may vary +/- 5% from actual product  
Measurements are presented in cm





NORTH HARBOUR



# NHB 3200 Mojo Polo

## Smart casual

65% Cotton 35% Polyester Lacoste  
Knitted tipping collar, cuffs & pocket  
Ribbed Polo collar  
Pearlized buttons  
Welt chest pocket  
Short sleeves with ribbed armbands  
Double-needle bottom hem  
Side vents at hem  
Casual, meet smart  
Classic fit  
Woven Label  
Sizes : S - 3XL  
RRP : 49.90 MYR / 19.90 SGD



NHB 3201  
Black / White / Black



NHB 3202  
White / Black / White



NHB 3203  
Navy / Yellow / White



NHB 3204  
Black / Red / White

Size	S	M	L	XL	2XL	3XL
Width	48	51	53	56	58	61
Length	68	71	73	76	79	81

Measurements may vary +/- 5% from actual product  
Measurements are presented in cm







NHB 3301  
Black /  
Sapphire / Charcoal



NHB 3302  
White /  
Red / Navy



NHB 3303  
Red /  
Charcoal / White



NHB 3304  
Yellow /  
Forest Green / White



# NHB 3300 COLLINS POLO

## Classic Fit

65% Cotton 35% Polyester Lacoste  
Knitted tipping collar & cuffs  
Ribbed Polo collar  
Stand collar half zip pullover  
Contrast color shoulder panel design  
Short sleeves with ribbed armbands  
Double-needle bottom hem  
Side vents at hem  
Casual, meet smart  
Woven Label  
Sizes : S - 3XL  
RRP : 49.90 MYR / 19.90 SGD

## Size Chart

Size	S	M	L	XL	2XL	3XL
Width	48	51	53	56	58	61
Length	68	71	73	76	79	81

Measurements may vary +/- 5% from actual product  
Measurements are presented in cm

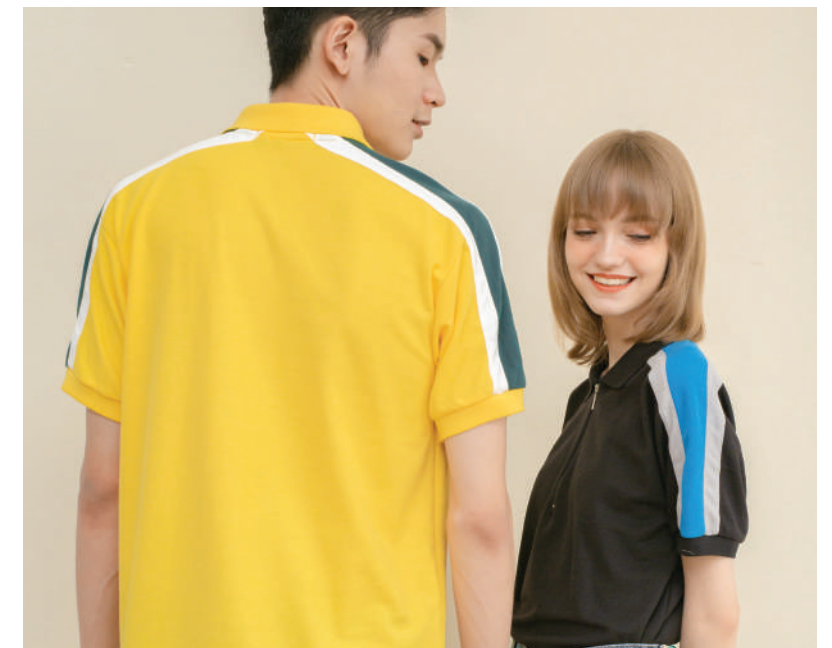





CROSSRUNNER®

## CRP 7200 Performance Polo

Incredibly quick drying, breathable, and cool. This handy item is great for any occasion. The comfy fit and colors make this item perfect for playing sports or just lounging around. 100% Performance dry pique material, to keep you fresh even in sweaty situations.



100% Performance Dry Pique  
Moisture-wicking performance fabric  
Polo neck, Solid-toned  
Soft feel, Antimicrobial, Anti-odor  
Greater stretch and recovery  
Extra mobility & range of motion  
Quick-dry, lightweight material  
Tagless heat transfer label  
Sizes : XS - 6XL  
RRP : 39.90 MYR / 16.90 SGD



Size	XS	S	M	L	XL	2XL	3XL	4XL	5XL	6XL
Width	46	48	51	53	56	58	61	63	66	68
Length	66	68	71	73	76	79	81	84	86	89

Measurements may vary +/- 5% from actual product  
Measurements are presented in cm



## P - 703 AIRtec Quick Dry Polo - Microfiber Mini Mesh

Made with high-quality, lightweight, quick-drying microfiber fabric, these shirts are suitable for casual hangouts with friends or as sports jerseys for athletic events.



100% Microfiber Jersey  
Adult Unisex  
Fiber content varies by color  
Quick-dry, lightweight material  
Double-needle sleeve and bottom hems  
Material: 100% Microfiber  
Fabric: Microfiber Mini Mesh  
Weight: 150 grams  
Size: XS - 7XL  
RRP : 34.90 MYR / 15.90 SGD



Size	XS	S	M	L	XL	2XL	3XL	5XL	7XL
Width	46	48	51	53	56	58	61	66	71
Length	63	66	68	71	73	76	79	86	91

Measurements may vary +/- 5% from actual product  
Measurements are presented in cm



## CRP 2100 INFINITE POLO

100% Performance Dry Pique  
Contrast color shoulder panel & sleeve  
Pearlized buttons  
Antimicrobial, Anti-odor  
Quick-dry, lightweight material  
Extra mobility & range of motion  
Greater stretch and recovery  
Soft feel, breathable performance  
Moisture-wicking performance fabric  
Satin label  
Sizes : S - 3XL  
RRP : 49.90 MYR / 19.90 SGD

Size	S	M	L	XL	2XL	3XL
Width	48	51	53	56	58	61
Length	68	71	73	76	79	81

Measurements may vary +/- 5% from actual product  
Measurements are presented in cm





# OXLEY POLO - CRP 2300

An item that is great not only for sports, but for everyday use.

CROSSRUNNER®



CRP 2301  
Black / Neon Green



CRP 2302  
Red / Charcoal



CRP 2303  
White / Black



CRP 2304  
Sapphire / Charcoal



CRP 2305  
Royal / White

100% Performance Dry Pique  
Classic elegant shoulder piping  
Pearlized buttons  
Antimicrobial, Anti-odor  
Quick-dry, lightweight material  
Extra mobility & range of motion

Greater stretch and recovery  
Soft feel, breathable performance  
Moisture-wicking performance fabric  
Satin label  
Sizes : S - 3XL  
RRP : 49.90 MYR / 19.90 SGD

Size	S	M	L	XL	2XL	3XL
Width	48	51	53	56	58	61
Length	68	71	73	76	79	81

Measurements may vary +/- 5% from actual product  
Measurements are presented in cm



CROSSRUNNER®

## CRP 2400 HENDERSON POLO

100% Performance Dry Pique  
Contemporary shoulder panel design  
Pearlized buttons  
Antimicrobial, Anti-odor  
Quick-dry, lightweight material  
Extra mobility & range of motion  
Greater stretch and recovery  
Soft feel, breathable performance  
Moisture-wicking performance fabric  
Satin label  
Sizes : S - 3XL  
RRP : 49.90 MYR / 19.90 SGD

Size	S	M	L	XL	2XL	3XL
Width	48	51	53	56	58	61
Length	68	71	73	76	79	81

Measurements may vary +/- 5% from actual product  
Measurements are presented in cm

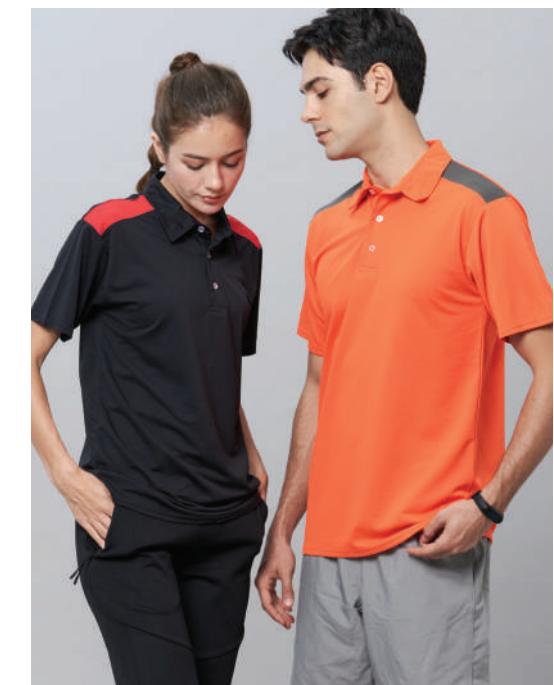

CRP 2401  
Sapphire / Charcoal



CRP 2402  
Orange / Charcoal



CRP 2403  
Black / Red



CRP 2404  
White / Sapphire





CROSSRUNNER®

# CRP 2500 OCEAN POLO

## Quick-drying

100% Performance Dry Pique  
 Classic tapping shoulder design  
 Pearlized buttons  
 Antimicrobial, Anti-odor  
 Quick-dry, lightweight material  
 Extra mobility & range of motion  
 Greater stretch and recovery  
 Soft feel, breathable performance  
 Moisture-wicking performance fabric  
 Best for training & lifestyle  
 Satin label  
 Sizes : S - 3XL  
 RRP : 49.90 MYR / 19.90 SGD



Size	S	M	L	XL	2XL	3XL
Width	48	51	53	56	58	61
Length	68	71	73	76	79	81

Measurements may vary +/- 5% from actual product  
 Measurements are presented in cm



# CRP 1300 DELTA POLO

## Light & Stretchy

100% Performance Dry Pique  
 Contrast color waist panel & piping design  
 Pearlized buttons  
 Antimicrobial, Anti-odor  
 Quick-dry, lightweight material  
 Extra mobility & range of motion  
 Greater stretch and recovery  
 Soft feel, breathable performance  
 Moisture-wicking performance fabric  
 Satin label  
 Sizes : S - 3XL  
 RRP : 49.90 MYR / 19.90 SGD



Size	S	M	L	XL	2XL	3XL
Width	48	51	53	56	58	61
Length	68	71	73	76	79	81

Measurements may vary +/- 5% from actual product  
 Measurements are presented in cm





## CRP 1400 EXPLORER POLO

Comfortable with great functionality and design. It keeps you dry, so it's perfect to wear every day and for when you're active. Soft material that disperses heat to keep you cool. High-quality material that produces vivid colors and feels great against the skin.



100% Performance Dry Pique  
 Contrast color waist panel design  
 Pearlized buttons  
 Antimicrobial, Anti-odor  
 Quick-dry, lightweight material  
 Extra mobility & range of motion  
 Greater stretch and recovery  
 Soft feel, breathable performance  
 Moisture-wicking performance fabric  
 Best for training & lifestyle  
 Satin label  
 Sizes : S - 3XL  
 RRP : 49.90 MYR / 19.90 SGD



CRP 1401  
Royal / Red



CRP 1402  
Orange / Sapphire



CRP 1403  
Lime / White



CRP 1404  
Heliconia / Black

Size	S	M	L	XL	2XL	3XL
Width	48	51	53	56	58	61
Length	68	71	73	76	79	81

Measurements may vary +/- 5% from actual product  
 Measurements are presented in cm

CROSSRUNNER®



## CRP 1500 FINISHER POLO

### Quick-drying

100% Performance Dry Pique  
 Contrast color piping design  
 Pearlized buttons  
 Antimicrobial, Anti-odor  
 Quick-dry, lightweight material  
 Extra mobility & range of motion  
 Greater stretch and recovery  
 Soft feel, breathable performance  
 Moisture-wicking performance fabric  
 Best for training & lifestyle  
 Satin label  
 Sizes : S - 3XL  
 RRP : 49.90 MYR / 19.90 SGD



CRP 1501  
White / Navy



CRP 1502  
Maroon / White



CRP 1503  
Purple / White



CRP 1504  
Royal / White



CRP 1505  
Tiffany Blue / Charcoal

Size	S	M	L	XL	2XL	3XL
Width	48	51	53	56	58	61
Length	68	71	73	76	79	81

Measurements may vary +/- 5% from actual product  
 Measurements are presented in cm





CROSSRUNNER®

## CRP 1600 RACER POLO

Light & Stretchy



CRP 1601  
Navy  
Red / White



CRP 1602  
Forest Green  
Gold / White



CRP 1603  
White  
Neon Green / Charcoal



CRP 1604  
Maroon  
Heliconia / White



CRP 1605  
Black  
Daisy / Charcoal

100% Performance Dry Pique  
Contrast color shoulder panel design  
Pearlized buttons  
Antimicrobial, Anti-odor  
Quick-dry, lightweight material  
Extra mobility & range of motion  
Greater stretch and recovery  
Soft feel, breathable performance  
Moisture-wicking performance fabric  
Satin label  
Sizes : S - 3XL  
RRP : 49.90 MYR / 19.90 SGD

Size	S	M	L	XL	2XL	3XL
Width	48	51	53	56	58	61
Length	68	71	73	76	79	81

Measurements may vary +/- 5% from actual product  
Measurements are presented in cm



CROSSRUNNER®

## CRP 2900 PARAGON POLO

100% Performance Jacquard Pique  
Contrast piping design  
Stand collar half zip pullover  
Antimicrobial, Anti-odor  
Quick-dry, lightweight material  
Extra mobility & range of motion  
Greater stretch and recovery  
Soft hand feel, breathable performance  
Moisture-wicking performance fabric  
Satin label  
Sizes : S - 3XL  
RRP : 49.90 MYR / 19.90 SGD

Size	S	M	L	XL	2XL	3XL
Width	48	51	53	56	58	61
Length	68	71	73	76	79	81

Measurements may vary +/- 5% from actual product  
Measurements are presented in cm



CRP 2901  
Red / White



CRP 2902  
Sapphire / White



CRP 2903  
Navy / White



CRP 2904  
Black / White

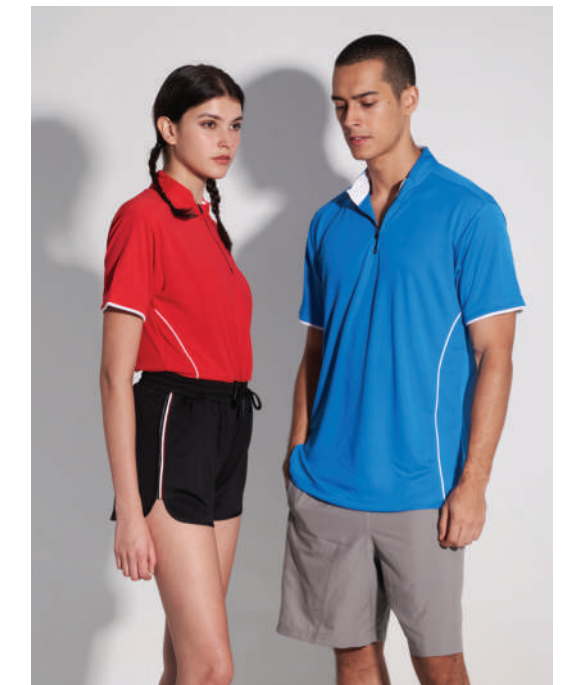





CROSSRUNNER®

# CRP 3100 HARLEY POLO

Light & Stretchy



CRP 3101  
Black  
Red / White



CRP 3102  
White  
Jade Dome / Navy



CRP 3103  
Gold Yellow  
Charcoal / Navy



CRP 3104  
Charcoal  
Navy / Forest Green

100% Performance Dry Pique  
Contrast color lower chest panel design  
Ribbed Polo collar  
Pearlized buttons  
Antimicrobial, Anti-odor  
Short sleeves with ribbed armbands  
Extra mobility & range of motion  
Soft feel, breathable performance  
Moisture-wicking performance fabric  
Satin label  
Sizes : XS - 3XL  
RRP : 49.90 MYR / 19.90 SGD

Size	XS	S	M	L	XL	2XL	3XL
Width	46	48	51	53	56	58	61
Length	66	68	71	73	76	79	81

Measurements may vary +/- 5% from actual product  
Measurements are presented in cm



CROSSRUNNER®

# CRP 3200 DYNAMIC POLO

100% Performance Dry Pique  
Knitted tipping collar & half zip pullover  
Contrast color shoulder panel design  
Special shape sliding design across sleeves  
Extra mobility & range of motion  
Quick-dry, lightweight material  
Greater stretch and recovery  
Antimicrobial, Anti-odor  
Soft feel, breathable performance  
Moisture-wicking performance fabric  
Satin label  
Sizes : XS - 3XL  
RRP : 49.90 MYR / 19.90 SGD

Size	XS	S	M	L	XL	2XL	3XL
Width	46	48	51	53	56	58	61
Length	66	68	71	73	76	79	81

Measurements may vary +/- 5% from actual product  
Measurements are presented in cm



CRP 3201  
Black  
Charcoal / White



CRP 3202  
Light Grey  
Navy / White



CRP 3203  
Royal  
Navy / White



CRP 3204  
Light Grey  
Red / White





CROSSRUNNER®



# CRP 2700 Phantom Polo

## Quick-drying

- Sublimated Jersey
- Performance Interlock
- Pearlized buttons
- Raglan classic styling
- Antimicrobial, Anti-odor
- Quick-dry, lightweight material
- Extra mobility & range of motion
- Greater stretch and recovery
- Soft feel, breathable performance
- Moisture-wicking performance fabric
- Tagless heat transfer label
- Sizes : XS - 3XL
- RRP : 49.90 MYR / 19.90 SGD



CRP 2701  
White



CRP 2702  
Charcoal



CRP 2703  
Royal



CRP 2704  
Daisy

Size	XS	S	M	L	XL	2XL	3XL
Width	46	48	51	53	56	58	61
Length	66	68	71	73	76	79	81

Measurements may vary +/- 5% from actual product  
Measurements are presented in cm





CROSSRUNNER®



# CRP 2800 Genotype Polo

## Quick-drying

Sublimated Jersey  
Performance Flat Knit  
Pearlized buttons  
Raglan classic styling  
Antimicrobial, Anti-odor  
Quick-dry, lightweight material  
Extra mobility & range of motion  
Greater stretch and recovery  
Soft feel, breathable performance  
Moisture-wicking performance fabric  
Tagless heat transfer label  
Sizes : XS - 3XL  
RRP : 49.90 MYR / 19.90 SGD



CRP 2801  
Light Grey



CRP 2802  
Daisy



CRP 2803  
Lime



CRP 2804  
Royal

Size	XS	S	M	L	XL	2XL	3XL
Width	46	48	51	53	56	58	61
Length	66	68	71	73	76	79	81

Measurements may vary +/- 5% from actual product  
Measurements are presented in cm

CROSSRUNNER®



# CRP 3000 PERPLEX POLO

Sublimated Jersey  
Performance Interlock  
Pearlized buttons  
Abstract linear pattern  
Antimicrobial, Anti-odor  
Quick-dry, lightweight material  
Extra mobility & range of motion  
Greater stretch and recovery  
Soft feel, breathable performance  
Tagless heat transfer label  
Sizes : XS - 3XL  
RRP : 49.90 MYR / 19.90 SGD

Size	XS	S	M	L	XL	2XL	3XL
Width	46	48	51	53	56	58	61
Length	66	68	71	73	76	79	81

Measurements may vary +/- 5% from actual product  
Measurements are presented in cm



CRP 3001  
Daisy



CRP 3002  
Red



CRP 3003  
Grey



CRP 3004  
Royal

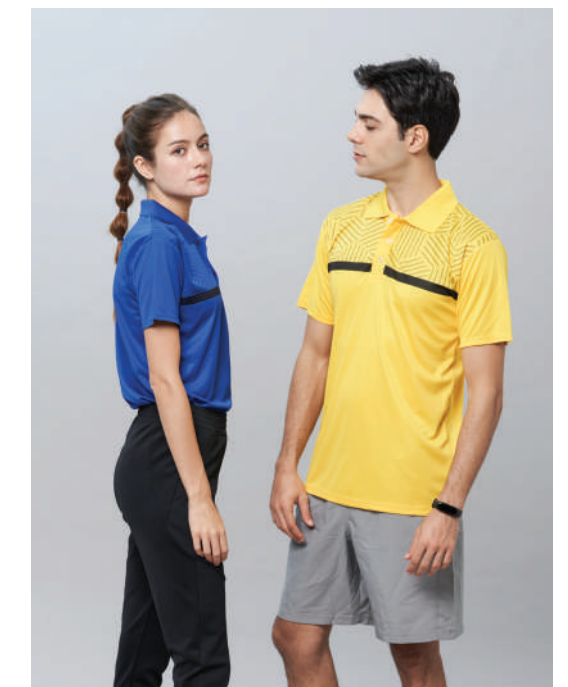



# CRR 3600 PERFORMANCE TEE

Incredibly quick drying, breathable, and cool. This handy item is great for any occasion. The comfy fit and colors make this item perfect for playing sports or just lounging around. 100% Performance dry pique material, to keep you fresh even in sweaty situations.



100% Performance Dry Pique  
Round neckline, Solid-toned tee  
Moisture-wicking performance fabric  
Antimicrobial, Anti-odor  
Soft feel, breathable performance  
Extra mobility & range of motion  
Quick-dry, lightweight material  
Tagless heat transfer label  
Sizes : XS - 6XL  
RRP : 29.90 MYR / 11.90 SGD

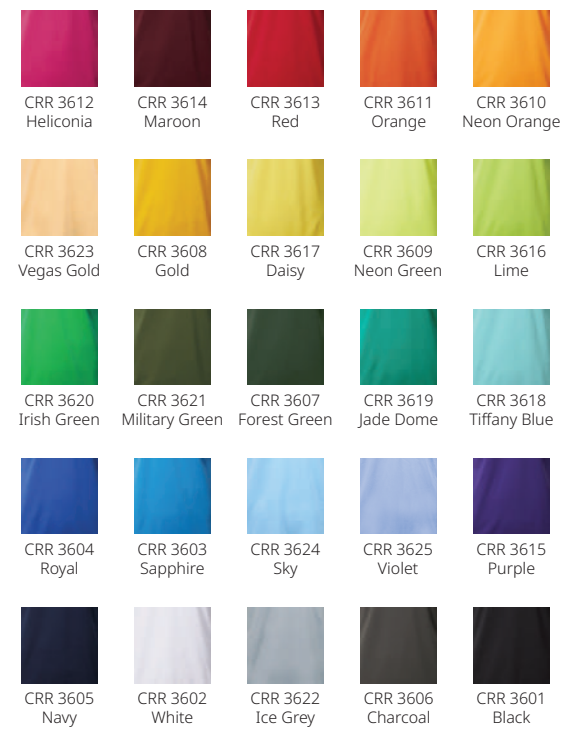

Size	XS	S	M	L	XL	2XL	3XL	4XL	5XL	6XL
Width	46	48	51	53	56	58	61	63	66	68
Length	66	68	71	73	76	79	81	84	86	89

Measurements may vary +/- 5% from actual product  
Measurements are presented in cm



CROSSRUNNER®



CROSSRUNNER®



100% Performance Jacquard Pique  
 Round neckline, Solid-toned tee  
 Soft and smooth handfeel  
 Moisture-wicking performance fabric  
 Antimicrobial, Anti-odor  
 Greater stretch and recovery  
 Extra mobility & range of motion  
 Double-needle sleeve and bottom hems  
 Tagless heat transfer label

## CRR 3900 Crossrunner Plus Performance Tee

Best for training & lifestyle  
 Quick-dry, breathable, lightweight material



Sizes : XS - 3XL  
 RRP : 39.90 MYR / 16.90 SGD

Size	XS	S	M	L	XL	2XL	3XL
Width	46	48	51	53	56	58	61
Length	66	68	71	73	76	79	81

Measurements may vary +/- 5% from actual product  
 Measurements are presented in cm





**P - 903**  
**AIRtec Quick Dry**  
**- Microfiber Mini Mesh**

Made with high-quality, lightweight, quick-drying microfiber fabric, these shirts are suitable for casual hangouts with friends or as sports jerseys for athletic events.



100% Microfiber Jersey  
 Adult Unisex  
 Double-needle sleeve and bottom hems  
 Weight: 150 grams  
 Size: XS - 7XL  
 RRP : 24.90 MYR / 10.90 SGD



Size	XS	S	M	L	XL	2XL	3XL	5XL	7XL
Width	46	48	51	53	56	58	61	66	71
Length	63	66	68	71	73	76	79	86	91

Measurements may vary +/- 5% from actual product  
 Measurements are presented in cm



**4B100**  
**Performance Adult**  
**Mesh T-Shirt**

**Inner Mesh Fabric**

155g/m<sup>2</sup> (4.6 oz/yd<sup>2</sup>)  
 100% polyester flatback mesh  
 Textured on the inside  
 Single needle 2 cm self-fabric collar  
 Taped back neck  
 Sideseamed  
 Double needle sleeve and bottom hems  
 Tear away label  
 7 colors  
 Sizes : XS - 2XL  
 RRP : 29.90 MYR / 11.90 SGD



Size	XS	S	M	L	XL	2XL
Width	44	47	50	53	56	59
Length	63	66	69	72	74	76

Measurements may vary +/- 5% from actual product  
 Measurements are presented in cm



# 4B100B

## Performance Youth Mesh T-shirt

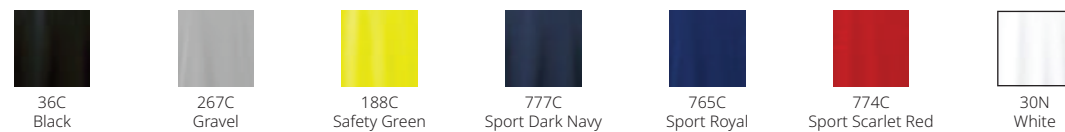

155g/m<sup>2</sup> (4.6 oz/yd<sup>2</sup>)  
 100% polyester flatback mesh  
 Single needle 1.5 cm self-fabric collar  
 Taped back neck  
 Sideseamed  
 Double needle sleeve and bottom hems

Tear away label  
 Best for training & lifestyle  
 Soft feel, breathable performance  
 7 colors  
 Sizes : YXXS - YXL  
 RRP : 25.90 MYR / 10.90 SGD

Size	YXXS	YXS	YS	YM	YL	YXL
Width	31	33	36	38	41	43
Length	43	45	48	51	54	58

Measurements may vary +/- 5% from actual product  
 Measurements are presented in cm

# CRR 3600B

## Youth Performance Tee

### Comfort & Quick dry

100% Performance Dry Pique  
 Round neckline, Solid-toned tee  
 Moisture-wicking performance fabric  
 Antimicrobial, Anti-odor  
 Greater stretch and recovery  
 Soft feel, breathable performance  
 Tagless heat transfer label  
 Sizes : YM - YL  
 RRP : 29.90 MYR / 11.90 SGD

Size	YM	YL
Width	35	38
Length	53	56

Measurements may vary +/- 5% from actual product  
 Measurements are presented in cm





# URBAN PLAYWEAR

Sports and everyday



## 9 colors



## CRR 36400 Performance Long Sleeve Tee

100% Performance Dry Pique  
Moisture-wicking performance fabric  
Round neckline, Solid-toned tee  
Antimicrobial, Anti-odor  
Greater stretch and recovery  
Extra mobility & range of motion  
Best for training & lifestyle  
Soft feel, breathable performance  
Quick-dry, lightweight material  
Tagless heat transfer label  
Sizes : XS - 3XL  
RRP : 32.90 MYR / 13.90 SGD



CROSSRUNNER®

Size	XS	S	M	L	XL	2XL	3XL
Width	46	48	51	53	56	58	61
Length	66	68	71	73	76	79	81

Measurements may vary +/- 5% from actual product  
Measurements are presented in cm



# CRR 1100 - STORM TEE

Made with functionality and style

CROSSRUNNER®



CRR 1101  
Black / White



CRR 1102  
Neon Green / Black



CRR 1103  
Navy / Red



CRR 1104  
Charcoal / Orange

100% Performance Dry Pique  
Contrast color panel & stitching  
Best for training & lifestyle  
Antimicrobial, Anti-odor  
Quick-dry, lightweight material  
Extra mobility & range of motion

Greater stretch and recovery  
Soft feel, breathable performance  
Moisture-wicking performance fabric  
Tagless heat transfer label  
Sizes : S - 3XL  
RRP : 39.90 MYR / 16.90 SGD

Size	S	M	L	XL	2XL	3XL
Width	48	51	53	56	58	61
Length	68	71	73	76	79	81

Measurements may vary +/- 5% from actual product  
Measurements are presented in cm

# CRR 1200 Velocity Polo

## Quick-drying

100% Performance Dry Pique  
Contrast color stitching design  
Antimicrobial, Anti-odor  
Quick-dry, lightweight material  
Extra mobility & range of motion  
Greater stretch and recovery  
Soft feel, breathable performance  
Moisture-wicking performance fabric  
Classic, comfort and iconic  
Best for training & lifestyle  
Tagless heat transfer label  
Sizes : S - 3XL  
RRP : 39.90 MYR / 16.90 SGD



CRR 1201  
Navy / Red



CRR 1202  
Black / White



CRR 1203  
White / Black



CRR 1204  
Neon Orange / Black



CRR 1205  
Red / Black

Size	S	M	L	XL	2XL	3XL
Width	48	51	53	56	58	61
Length	68	71	73	76	79	81

Measurements may vary +/- 5% from actual product  
Measurements are presented in cm



CROSSRUNNER®



CROSSRUNNER®



# CRR 1300 ZEN TEE

## Quick-drying

100% Performance Dry Pique  
 Contrast color panel design  
 Antimicrobial, Anti-odor  
 Quick-dry, lightweight material  
 Extra mobility & range of motion  
 Greater stretch and recovery  
 Soft feel, breathable performance  
 Moisture-wicking performance fabric  
 Classic, comfort and iconic  
 Best for training & lifestyle  
 Tagless heat transfer label  
 Sizes : S - 3XL  
 RRP : 39.90 MYR / 16.90 SGD



CRR 1301  
Navy / Red



CRR 1302  
Black / White



CRR 1303  
Sapphire / White



CRR 1304  
Neon Green / Black



CRR 1305  
Jade Dome / Charcoal

Size	S	M	L	XL	2XL	3XL
Width	48	51	53	56	58	61
Length	68	71	73	76	79	81

Measurements may vary +/- 5% from actual product  
 Measurements are presented in cm





CROSSRUNNER®



# CRR 1800 DENSE TEE

## Quick-drying

Sublimated Jersey  
 Performance Reverse Eyelet  
 Raglan classic styling  
 Urban camouflage pattern  
 Antimicrobial, Anti-odor  
 Quick-dry, lightweight material  
 Extra mobility & range of motion  
 Greater stretch and recovery  
 Soft feel, breathable performance  
 Moisture-wicking performance fabric  
 Tagless heat transfer label  
 Sizes : XS - 3XL  
 RRP : 39.90 MYR / 16.90 SGD



CRR 1801  
Light Grey



CRR 1802  
Milo Green



CRR 1803  
Daisy



CRR 1804  
Light Blue



CRR 1805  
Charcoal

Size	XS	S	M	L	XL	2XL	3XL
Width	46	48	51	53	56	58	61
Length	66	68	71	73	76	79	81

Measurements may vary +/- 5% from actual product  
 Measurements are presented in cm





CROSSRUNNER®



# CRR 1900 Trimosaic Tee

## Quick-drying

Sublimated Jersey  
Performance Interlock  
Raglan classic styling  
Urban geometric mosaic pattern  
Antimicrobial, Anti-odor  
Quick-dry, lightweight material  
Extra mobility & range of motion  
Greater stretch and recovery  
Soft feel, breathable performance  
Moisture-wicking performance fabric  
Tagless heat transfer label  
Sizes : XS - 3XL  
RRP : 39.90 MYR / 16.90 SGD



CRR 1901  
Milo Green



CRR 1902  
Daisy



CRR 1903  
Sapphire



CRR 1904  
Heliconia

Size	XS	S	M	L	XL	2XL	3XL
Width	46	48	51	53	56	58	61
Length	66	68	71	73	76	79	81

Measurements may vary +/- 5% from actual product  
Measurements are presented in cm

CROSSRUNNER®



# CRR 2000 FOXCHARM TEE

Sublimated Jersey  
Performance Interlock  
Raglan classic styling  
Modern abstract chevron pattern  
Antimicrobial, Anti-odor  
Quick-dry, lightweight material  
Extra mobility & range of motion  
Greater stretch and recovery  
Soft feel, breathable performance  
Moisture-wicking performance fabric  
Tagless heat transfer label  
Sizes : XS - 3XL  
RRP : 39.90 MYR / 16.90 SGD

Size	XS	S	M	L	XL	2XL	3XL
Width	46	48	51	53	56	58	61
Length	66	68	71	73	76	79	81

Measurements may vary +/- 5% from actual product  
Measurements are presented in cm



CRR 2001  
Daisy



CRR 2002  
Royal



CRR 2003  
Purple



CRR 2004  
Sapphire







# CRR 2100 MATRIX TEE

## Quick-drying

- Sublimated Jersey
- Performance Interlock
- Raglan classic styling
- Minimal triangles modern pattern
- Antimicrobial, Anti-odor
- Quick-dry, lightweight material
- Extra mobility & range of motion
- Greater stretch and recovery
- Soft feel, breathable performance
- Moisture-wicking performance fabric
- Tagless heat transfer label
- Sizes : XS - 3XL
- RRP : 39.90 MYR / 16.90 SGD



CRR 2101  
Charcoal



CRR 2102  
Royal



CRR 2103  
Red



CRR 2104  
Maroon

Size	XS	S	M	L	XL	2XL	3XL
Width	46	48	51	53	56	58	61
Length	66	68	71	73	76	79	81

Measurements may vary +/- 5% from actual product  
Measurements are presented in cm





# CRR 2200 - ADORN TEE

Best for training & lifestyle



CRR 2201  
Navy



CRR 2202  
Royal



CRR 2203  
Maroon



CRR 2204  
Forest Green

Sublimated Jersey  
Sleeve - 100% Performance Jacquard Pique  
Body - 100% Performance Dry Pique  
Raglan classic styling  
Antimicrobial, Anti-odor  
Quick-dry, lightweight material

Extra mobility & range of motion  
Soft feel, breathable performance  
Moisture-wicking performance fabric  
Tagless heat transfer label  
Sizes : XS - 3XL  
RRP : 39.90 MYR / 16.90 SGD

Size	XS	S	M	L	XL	2XL	3XL
Width	46	48	51	53	56	58	61
Length	66	68	71	73	76	79	81

Measurements may vary +/- 5% from actual product  
Measurements are presented in cm

# CRR 2300 Splendid Tee

## Quick-drying

Sublimated Jersey  
Performance Interlock  
Rhythm diagonal stripes design  
Raglan classic styling  
Antimicrobial, Anti-odor  
Quick-dry, lightweight material  
Extra mobility & range of motion  
Greater stretch and recovery  
Soft feel, breathable performance  
Moisture-wicking performance fabric  
Tagless heat transfer label  
Sizes : XS - 3XL  
RRP : 39.90 MYR / 16.90 SGD



CRR 2301  
Green



CRR 2302  
Daisy



CRR 2303  
Turq Blue



CRR 2304  
Orange

Size	XS	S	M	L	XL	2XL	3XL
Width	46	48	51	53	56	58	61
Length	66	68	71	73	76	79	81

Measurements may vary +/- 5% from actual product  
Measurements are presented in cm







CROSSRUNNER®

# CRV 1300 Seize Running Vest

## Quick-drying

Sublimated Jersey  
Performance Reverse Eyelet  
Athletic ringer design  
Antimicrobial, Anti-odor  
Quick-dry, lightweight material  
Best for training & lifestyle  
Greater stretch and recovery  
Soft feel, breathable performance  
Moisture-wicking performance fabric  
Classic, comfort and iconic  
Tagless heat transfer label  
Superior Retail Fit : S - 3XL  
RRP : 35.90 MYR / 19.90 SGD



CRV 1301  
Lt. Grey / Turq Blue



CRV 1302  
Red / Lt. Blue



CRV 1303  
Milo Green / Black



CRV 1304  
Royal / Daisy

Size	S	M	L	XL	2XL	3XL
Width	48	51	53	56	58	61
Length	68	71	73	76	79	81

Measurements may vary +/- 5% from actual product  
Measurements are presented in cm



CROSSRUNNER®

# CRV 1600 Flex Running Vest

100% Performance Dry Pique  
Running vest styling  
Contrast color panel design  
Antimicrobial, Anti-odor  
Greater stretch and recovery  
Quick-dry, lightweight material  
Extra mobility & range of motion  
Soft feel, breathable performance  
Moisture-wicking performance fabric  
Best for training & lifestyle  
Tagless heat transfer label  
Sizes : S - 3XL  
RRP : 35.90 MYR / 14.90 SGD

Size	S	M	L	XL	2XL	3XL
Width	48	51	53	56	58	61
Length	68	71	73	76	79	81

Measurements may vary +/- 5% from actual product  
Measurements are presented in cm



CRV 1601  
N. Orange / Charcoal



CRV 1602  
White / Black



CRV 1603  
Red / Black



CRV 1604  
N. Green / Black



CRV 1605  
Royal / Black





## CRV 1700 RACER POLO

Quick-drying



100% Performance Jacquard Pique  
Round neckline, Solid-toned tank  
Soft and smooth handfeel  
Antimicrobial, Anti-odor  
Moisture-wicking performance fabric  
Antimicrobial, Anti-odor  
Greater stretch and recovery  
Extra mobility & range of motion  
Double-needle bottom hems  
Tagless heat transfer label  
Sizes : S - 3XL  
RRP : 35.90 MYR / 19.90 SGD

Size	S	M	L	XL	2XL	3XL
Width	48	51	53	56	58	61
Length	68	71	73	76	79	81

Measurements may vary +/- 5% from actual product  
Measurements are presented in cm



## CRT 1200 J NEIL TRACK JACKET

Performance Eyelet  
Zip up fastening  
Stand collar  
Contrast color panel & piping  
Rib hem and cuffs  
Slanted welt pockets  
Quick-dry, lightweight material  
Soft feel, breathable performance  
Moisture-wicking performance fabric  
Best for training & lifestyle  
Satin Label  
Sizes : XS - 2XL  
RRP : 69.90 MYR / 27.90 SGD

Size	XS	S	M	L	XL	2XL
Width	48	51	53	56	58	60
Length	62	64	67	70	72	75

Measurements may vary +/- 5% from actual product  
Measurements are presented in cm







CROSSRUNNER®

## CRT 1100 P Zeal Active Trackpants

### Stress-free Comfort

- Performance Flat Knit (Black)
- Poly Tricot Brush (Dark Grey)
- Elastic waistband
- Functional drawcord waistband
- Welt side pockets
- Elasticised ankle cuffs
- Unisex design
- Relaxed fit
- Satin Label
- Superior Retail Fit : XS - 2XL
- RRP : 49.90 MYR / 19.90 SGD



CRT 1101 P  
Black



CRT 1102 P  
Dark Grey



### Size Chart

Size	XS	S	M	L	XL	2XL
Waist Relaxed	33	35	38	40	43	45
Waist Extended	38	40	43	45	48	51
Outseam	99	101	104	106	109	111

Measurements may vary +/- 5% from actual product  
Measurements are presented in cm

## CRS 1100 Elite Training Shorts

- Performance Interlock
- Unisex design
- Elastic waistband
- Functional drawcord waistband
- Quick-dry, lightweight comfort
- Unisex design
- Relaxed fit
- Satin Label
- Sizes : S - XL
- RRP : 35.90 MYR / 19.90 SGD

Size	S	M	L	XL
Waist Relaxed	33	35	38	40
Waist Extended	45	47	47	49
Outseam	39	40	41	42

Measurements may vary +/- 5% from actual product  
Measurements are presented in cm



CROSSRUNNER®

### 4 colors



CRS 1101  
Black



CRS 1102  
Navy



CRS 1103  
Royal



CRS 1104  
Red





PANBASIC

## P - 501 Microfiber Track Pants

Material : 100% Polyester  
 Fabric : Microfiber  
 Weight : 110 grams  
 Drawcord On Waist  
 Sides Pocket  
 Back Pocket With Zip  
 Flat Opening Legs  
 Quick-dry, lightweight material  
 Adult Unisex  
 Size : S - 2XL  
 RRP : 39.90 MYR / 16.90 SGD

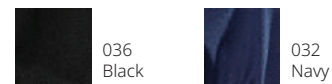

Size	S	M	L	XL	2XL
Waist Relaxed	33	34	35	37	38
Waist Extended	51	53	56	58	61
Hip	52	53	57	58	62
Outseam	97	99	101	104	106

Measurements may vary +/- 5% from actual product  
 Measurements are presented in cm



## P - 502 Microfiber Track Pants

### Stress-free Comfort

Material : 100% Polyester  
 Fabric : Microfiber  
 Weight : 110 grams  
 Drawcord On Waist  
 Sides Pocket  
 Back Pocket With Zip  
 Grip opening legs with zip  
 Quick-dry, lightweight material  
 Adult Unisex  
 Size : S - 2XL  
 RRP : 39.90 MYR / 16.90 SGD



## Size Chart

Size	S	M	L	XL	2XL
Waist Relaxed	33	34	35	37	38
Waist Extended	51	53	56	58	61
Hip	52	53	57	58	62
Outseam	98	100	103	105	107

Measurements may vary +/- 5% from actual product  
 Measurements are presented in cm





## CRB 1100 Vanguard Basketball Suit

Bold alternative colours and details distinguish the Statement Edition, a jersey that symbolises the collective strength, spirit and competitive mindset of the roster. It's made from premium eyelet fabric with an easy, relaxed fit that looks great on court.



- Performance Eyelet
- V neckline
- Contrast color matching panel design
- Elastic waistband
- Moisture-wicking performance fabric
- Antimicrobial, Anti-odor
- Extra mobility & range of motion
- Breathable performance
- Quick-dry, lightweight material
- Tagless heat transfer label
- Sizes : S - 2XL
- RRP : 69.90 MYR / 27.90 SGD



CRB 1101  
Red  
Maroon  
White

CRB 1102  
Royal  
Daisy  
White

CRB 1103  
Maroon  
Light Grey  
White

CRB 1104  
Black  
Orange  
White

### TOPS

Size	S	M	L	XL	2XL
Width	48	51	53	56	58
Length	68	71	73	76	78

Measurements may vary +/- 5% from actual product  
Measurements are presented in cm

### BOTTOMS

Size	S	M	L	XL	2XL
Waist Relaxed	35	38	40	43	45
Waist Extended	40	43	45	48	51
Outseam	45	48	51	53	56

Measurements may vary +/- 5% from actual product  
Measurements are presented in cm







# NHJ 1100 BOMBER JACKET

Light and comfortable, versatile and contemporary design for any moment. If you are looking for a garment with its own personality, the bomber jacket is the right option to combine with your entire wardrobe in any of the colours we offer.



Solid tone bomber jacket  
Long sleeve  
Light weight polyester pongee  
Interlining with 210t polyester  
Wind resistant fabric  
Stand collar neckline  
Elasticated cuffs and hem  
2 front side pockets  
1 inner pocket  
Front zip fastening  
Satin label  
Sizes : XS - 3XL  
RRP : 69.90 MYR / 27.90 SGD

-  NHJ 1105  
Army Green
-  NHJ 1102  
Light Grey
-  NHJ 1104  
Black
-  NHJ 1103  
Navy
-  NHJ 1101  
Burgundy

Size	XS	S	M	L	XL	2XL	3XL
Width	51	53	55	57	59	61	63
Length	64	66	68	70	72	74	76

Measurements may vary +/- 5% from actual product  
Measurements are presented in cm







## NHJ 2100 FlipIt Reversible Jacket

High neckline  
 Front zip fastening  
 Elastic cuffs and hem  
 Face: poly tricot / Back: poly pongee  
 2 front side pockets; 2 front zip pockets  
 Reversible with dual toned design on one side  
 Regular fit  
 Woven label  
 Sizes : XS - 3XL  
 RRP : 89.90 MYR / 35.90 SGD

Size	XS	S	M	L	XL	2XL	3XL
Width	51	53	55	57	59	61	63
Length	64	66	68	70	72	74	76

Measurements may vary +/- 5% from actual product  
 Measurements are presented in cm



NORTH HARBOUR

## Stylish and functional



NHJ 2101 - Navy / Black



NHJ 2102 - Sky Blue / Navy



NHJ 2103 - Black / Dark Grey





**GILDAN**  
Heavy Blend™

OEKO-TEX®  
CONFIDENCE IN TEXTILES  
**STANDARD 100**  
68255 OeTI  
Tested for harmful substances  
www.oeko-tex.com/standard100

285 g/m<sup>2</sup> (8.4 oz/yd<sup>2</sup>)  
2 x 1 rib with spandex  
Sideseamed  
Best for lifestyle  
Regular fit  
Authentic sweat fabric  
Satin label

Double-needle stitching at waistband and cuffs  
Straight cut suits all body types

## 88000 Adult Crewneck Sweatshirt

50% cotton / 50% polyester preshrunk fleece knit  
Versatile sweats for all outfits and occasions



Sizes : XS - 2XL  
RRP : 79.90 MYR / 29.90 SGD

Size	XS	S	M	L	XL	2XL
Width	48	51	53	56	61	64
Length	62	65	67	70	73	75

Measurements may vary +/- 5% from actual product  
Measurements are presented in cm





**GILDAN**  
Heavy Blend™

OEKO-TEX®  
CONFIDENCE IN TEXTILES  
**STANDARD 100**  
68255 OeTI  
Tested for harmful substances  
www.oeko-tex.com/standard100



30 N  
White



40 C  
Red



10 C  
Heliconia



81 C  
Purple



51 C  
Royal



32 C  
Navy



95 H  
Sport Grey



108 C  
Dark Heather



36 C  
Black



## 88500 Adult Hooded Sweatshirt

285 g/m<sup>2</sup> (8.4 oz/yd<sup>2</sup>)  
50% cotton / 50% polyester preshrunk fleece knit  
Double-needle stitching at waistband and cuffs  
Double-lined hood with color-matched drawcord  
2 x 1 rib with spandex  
Pouch pockets  
Sideseamed  
Satin label  
Sizes : XS - 2XL  
RRP : 89.90 MYR / 32.90 SGD

Size	XS	S	M	L	XL	2XL
Width	48	51	53	56	61	64
Length	62	65	67	70	73	75

Measurements may vary +/- 5% from actual product  
Measurements are presented in cm







## 88600 Adult Full Zip Hooded Sweatshirt

285 g/m<sup>2</sup> (8.4 oz/yd<sup>2</sup>)  
 50% cotton / 50% polyester preshrunk fleece knit  
 Double-needle stitching at waistband and cuffs  
 Unlined hood with color-matched drawcord  
 Metal Zipper  
 Pouch pockets  
 2 x 1 rib with spandex  
 Sideseamed  
 9 colors  
 Satin label  
 Sizes : XS - 2XL  
 RRP : 89.90 MYR / 32.90 SGD



## The Outerwear Trends



Size	XS	S	M	L	XL	2XL
Width	48	51	53	56	61	64
Length	62	65	67	70	73	75

\*MEASUREMENTS ARE PRESENTED IN CM







-  276 C  
Tweed
-  286 C  
Midnight
-  278 C  
Blackberry
-  284 C  
Lilac
-  261 C  
Moss
-  277 C  
Meadow
-  274 C  
Russet
-  285 C  
Sunset

Sizes : S - XL  
RRP : 79.90 MYR / 31.90 SGD

Size	S	M	L	XL
Width	49	54	59	64
Length	65	67	70	72

Measurements may vary +/- 5% from actual product  
Measurements are presented in cm



## 18700 - Adult Vintage Full Zip Hooded Sweatshirt

270 g/m<sup>2</sup> (8 oz/yd<sup>2</sup>)  
 50% cotton / 50% polyester  
 Air jet yarn = softer feel and reduced pilling  
 Double-needle stitching at shoulder, armhole, neck, waistband and cuffs  
 Preshrunk fleece knit, Cross dyed shades (2 colors in one fabric)  
 Pouch pockets  
 1 x 1 rib with spandex  
 Unlined hood, Contrast dark grey flatcord  
 Brass zipper with contrast dark grey trim  
 Quarter-turned to eliminate center crease  
 Satin label





**GILDAN**  
Heavy Blend™



## 18800 - Adult Vintage Cadet Collar Sweatshirt

270 g/m<sup>2</sup> (8 oz/yd<sup>2</sup>)  
 50% cotton / 50% polyester  
 Preshrunk fleece knit  
 Air jet yarn = softer feel and reduced pilling  
 Cross dyed shades (2 colors in one fabric)  
 Self fabric lined collar  
 Satin label  
 Contrast dark grey twill tape  
 1/4 brass zipper with contrast dark grey trim  
 Double-needle stitching at shoulder,  
 armhole, waistband and cuffs  
 1 x 1 rib with spandex  
 Quarter-turned to eliminate center crease  
 Sizes : S - XL  
 RRP : 79.90 MYR / 31.90 SGD

Size	S	M	L	XL
Width	51	56	60	66
Length	68	71	73	76

Measurements may vary +/- 5% from actual product  
 Measurements are presented in cm

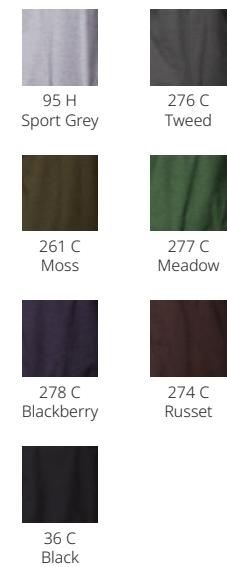





- CRJ 1101  
Red / White
- CRJ 1102  
Black / White
- CRJ 1103  
Royal / White
- CRJ 1104  
Navy / White
- CRJ 1105  
Sport Grey / White
- CRJ 1106  
Maroon / White



## CRJ 1100 VARSITY JACKET

60% Cotton 40% Polyester CVC Fleece  
Varsity style jacket with tipping detail  
Striped rib-knit cuffs & collar  
Short stand collar  
Slanted welt pockets  
Straight cut suits all body types  
Authentic sweat fabric  
Satin Label  
Sizes : S - 3XL  
RRP : 69.90 MYR / 27.90 SGD

Size	S	M	L	XL	2XL	3XL
Width	51	53	56	58	60	63
Length	70	72	75	77	80	82

Measurements may vary +/- 5% from actual product  
Measurements are presented in cm







## CRJ 1200 LIFESTYLE JACKET

Sublimated Casual Jacket  
 Performance Flat Knit  
 Multi tone design  
 Zip up fastening  
 Mandarin stand collar  
 Slanted welt pockets  
 Rib collar, cuffs and hem  
 Lightweight material  
 Soft feel, breathable performance  
 Moisture-wicking performance fabric  
 Satin Label  
 Sizes : XS - 2XL  
 RRP : 79.90 MYR / 31.90 SGD



CRJ 1201  
Navy  
Red / White



CRJ 1202  
Daisy  
White / Navy



CRJ 1203  
Lt. Blue  
Daisy / Black



CRJ 1204  
Royal  
White / Black

Size	XS	S	M	L	XL	2XL
Width	48	51	53	56	58	60
Length	68	68	71	71	73	73

Measurements may vary +/- 5% from actual product  
 Measurements are presented in cm







## NHB 1400 PREMIUM OXFORD

100% Premium Cotton Oxford  
 More opaque material, high-quality fabric  
 Pearlized buttons  
 Button-through sleeve plackets  
 Meticulous attention to detail with a long hem  
 Rounded hemline  
 Woven Label  
 Sizes : S - 3XL  
 RRP : 79.90 MYR / 31.90 SGD

Size	S	M	L	XL	2XL	3XL
Width	50	53	55	58	60	63
Length	77	79	81	82	84	85

Measurements may vary +/- 5% from actual product  
 Measurements are presented in cm



NORTH HARBOUR



NHB 1401  
Black





NHB 1402  
White



NHB 1403  
Charcoal





-  NHB 1501  
Black
-  NHB 1502  
White
-  NHB 1503  
Charcoal



# NHB 1500 Premium Oxford

## Short Sleeve

100% Premium Cotton Oxford  
 More opaque material, high-quality fabric  
 Regular collar completes the look  
 Pearlized buttons  
 Great for both casual and dressier looks  
 Meticulous attention to detail with a long hem  
 Rounded hemline  
 Woven Label  
 Superior Retail Fit :  
 Sizes : S - 3XL  
 RRP : 79.90 MYR / 31.90 SGD

## Size Chart

Size	S	M	L	XL	2XL	3XL
Width	50	53	55	58	60	63
Length	77	79	81	82	84	85

Measurements may vary +/- 5% from actual product  
 Measurements are presented in cm







NORTH HARBOUR

## NHB 2000 Cotton Rayon Shirt

65% Cotton 35% Rayon  
 Pearlized buttons  
 Wrinkle-resistant even after washing for easy care  
 Smoother, more opaque material  
 Light and comfortable, high-quality fabric  
 Excellent breathability provides cool comfort  
 Button-through sleeve plackets  
 Meticulous attention to detail with a long hem  
 Rounded hemline  
 Woven Label  
 Sizes : S - 3XL  
 RRP : 79.90 MYR / 31.90 SGD



Size	S	M	L	XL	2XL	3XL
Width	50	53	55	58	60	63
Length	77	79	81	82	84	85

Measurements may vary +/- 5% from actual product  
 Measurements are presented in cm







-  NHB 1701  
Lavender / White
-  NHB 1702  
Royal / White
-  NHB 1703  
Navy / White
-  NHB 1704  
Orange / White
-  NHB 1705  
Charcoal / White
-  NHB 1706  
Red / White



# NHB 1700 Synergy Racewear

## Premium Workwear

65% Viscose 35% Polyester  
 Pearlized buttons  
 Front button placket  
 Pocket on the chest  
 Contrast piping design  
 Meticulous attention to detail with a long hem  
 Rounded hemline  
 Woven Label  
 Superior Retail Fit :  
 Sizes : S - 3XL  
 RRP : 69.90 MYR / 27.90 SGD

## Size Chart

Size	S	M	L	XL	2XL	3XL
Width	50	53	55	58	60	63
Length	77	79	81	82	84	85

Measurements may vary +/- 5% from actual product  
 Measurements are presented in cm







NORTH HARBOUR

## NHB 1800 Impact Racewear

65% Viscose 35% Polyester  
 Pearlized buttons  
 Collar neckline  
 Front buttons fastening  
 Welt pocket on the chest  
 Contrast color panel design  
 Back pleat detail  
 Meticulous attention to detail with a long hem  
 Rounded hemline  
 Regular fit  
 Woven Label  
 Sizes : S - 3XL  
 RRP : 69.90 MYR / 27.90 SGD

Size	S	M	L	XL	2XL	3XL
Width	50	53	55	58	60	63
Length	77	79	81	82	84	85

Measurements may vary +/- 5% from actual product  
 Measurements are presented in cm



NHB 1801  
Gold / Royal



NHB 1802  
Sapphire / White



NHB 1803  
Red / Gravel



NHB 1804  
Dark Charcoal / Lime

# NHB 1900 - SMART RACEWEAR

To bring style and comfort



NORTH HARBOUR



NHB 1901  
White / Navy



NHB 1902  
Sapphire / White



NHB 1903  
Red / Black



NHB 1904  
Charcoal / White

65% Viscose 35% Polyester  
 Pearlized buttons  
 Collar neckline  
 Front buttons fastening  
 Pocket on the chest  
 Contrast color design collar & sleeve

Back pleat detail  
 Rounded hemline  
 Regular fit  
 Woven Label  
 Sizes : S - 3XL

RRP : 69.90 MYR / 27.90 SGD

Size	S	M	L	XL	2XL	3XL
Width	50	53	55	58	60	63
Length	77	79	81	82	84	85

Measurements may vary +/- 5% from actual product  
 Measurements are presented in cm



NORTH HARBOUR



# NHB 2600 Murphy Racewear

## Premium Workwear

65% Viscose 35% Polyester  
 Pearlized buttons  
 Collar neckline  
 Front buttons fastening  
 Bold color matching sleeve  
 Meticulous attention to detail with a long hem  
 Rounded hemline  
 Regular fit  
 Woven Label  
 Sizes : S - 3XL  
 RRP : 69.90 MYR / 27.90 SGD



NHB 2601  
White  
Red / Navy



NHB 2602  
Navy  
White / Red



NHB 2603  
Red  
White / Black



NHB 2604  
Royal  
Charcoal / Navy



NHB 2605  
Sapphire  
Navy / White

Size	S	M	L	XL	2XL	3XL
Width	50	53	55	58	60	63
Length	77	79	81	82	84	85

Measurements may vary +/- 5% from actual product  
 Measurements are presented in cm







NHB 3001  
White / Red / Black



NHB 3002  
Red / White / Navy



NHB 3003  
Navy / White / Red



NHB 3004  
Black / White / Red



# NHB 3000 CYRIL SHIRT

## Premium Workwear

65% Viscose 35% Polyester  
 Knitted tipping collar & cuffs  
 Pearlized buttons  
 Front buttons fastening  
 Great for both casual and dressier looks  
 Meticulous attention to detail with a long hem  
 Rounded hemline  
 Regular fit  
 Woven Label  
 Sizes : S - 3XL  
 RRP : 69.90 MYR / 27.90 SGD

### Size Chart

Size	S	M	L	XL	2XL	3XL
Width	50	53	55	58	60	63
Length	77	79	81	82	84	85

Measurements may vary +/- 5% from actual product  
 Measurements are presented in cm







NHB 3101  
Sky



NHB 3102  
Earl Blue



NHB 3103  
Midnight

Size	S	M	L	XL	2XL	3XL
Width	50	53	55	58	60	63
Length	77	79	81	82	84	85

Measurements may vary +/- 5% from actual product  
Measurements are presented in cm



## NHB 3100 - Virgil Shirt

100% Soft cotton denim  
 Pearlized buttons  
 Front button placket  
 Regular collar completes the look  
 Button-through sleeve plackets  
 Great for both casual and dressier looks  
 Light and comfortable, soft hand feel material  
 Meticulous attention to detail with a long hem  
 Rounded hemline  
 Woven Label  
 Sizes : S -3XL  
 RRP : 69.90 MYR / 27.90 SGD







-  NHB 3401  
Black
-  NHB 3402  
Fortune Red
-  NHB 3403  
Emerald Green
-  NHB 3404  
Olive Green



# NHB 3400 Charms Shirt

## Short Sleeve

65% Cotton 35% Rayon  
 Mandarin Collar  
 Stand collared neckline  
 Pearlized buttons  
 Wrinkle-resistant even after washing for easy care  
 Smoother, more opaque material  
 Light and comfortable, high-quality fabric  
 Excellent breathability provides cool comfort  
 Rounded hemline  
 Woven Label  
 Sizes : S -3XL  
 RRP : 69.90 MYR / 27.90 SGD

## Size Chart

Size	S	M	L	XL	2XL	3XL
Width	50	53	55	58	60	63
Length	77	79	81	82	84	85

Measurements may vary +/- 5% from actual product  
 Measurements are presented in cm







# SMW 1300 INAYAH

## Muslimah Wear

40% Cotton 60% Polyester  
Mandarin collar  
Classic two color panel  
Waistline pocket feature  
Superior Retail Fit :  
Ladies fitting from S to 3XL  
RRP : 59.90 MYR / 23.90 SGD



SMW 1301  
Daisy / Forest Green



SMW 1302  
Maroon / Heliconia



SMW 1303  
Black / Charcoal



SMW 1304  
Purple / Red

Size	S	M	L	XL	2XL	3XL
Width	48	51	53	56	58	60
Length	89	91	94	96	99	101

Measurements may vary +/- 5% from actual product  
Measurements are presented in cm



# SMW 1300M IYADH MUSLIMIN

40% Cotton 60% Polyester  
Welded collar and placket  
Classic two color panel  
Polo collar neckline  
Regular fit  
Button fastening  
Superior Retail Fit :  
Men fitting from S to 3XL  
RRP : 59.90 MYR / 23.90 SGD

Size	S	M	L	XL	2XL	3XL
Width	48	51	53	56	58	60
Length	68	71	73	76	79	81

Measurements may vary +/- 5% from actual product  
Measurements are presented in cm



SMW 1301 M  
Daisy / Forest Green



SMW 1302 M  
Maroon / Heliconia



SMW 1303 M  
Black / Charcoal



SMW 1304 M  
Purple / Red



# SMW 1500 - AMMARA

Embracing the beauty of all women.

SARRA®



40% Cotton 60% Polyester  
Sporty Raglan design  
Long sleeves  
Round neckline  
Waistline pocket feature  
New asian A shape muslimah cutting

Regular fit  
Woven label  
Superb Comfort  
Superior Retail Fit :  
Ladies fitting from S to 3XL  
RRP : 59.90 MYR / 23.90 SGD

Size	S	M	L	XL	2XL	3XL
Width	48	51	53	56	58	60
Length	89	91	94	96	99	101

Measurements may vary +/- 5% from actual product  
Measurements are presented in cm

## SMW 1500M - ADAM Muslimin Wear Collection

Sarra are caters to everyday modern Muslims with its wide variety of comfortable and stylish Muslim wear. Always bring the perfect outlook for men who wear it, fulfill the needs of fashion and comfortability. Sarra is an importance piece to earn by the modern Muslim.



40% Cotton 60% Polyester  
Welded collar and placket  
Sporty Raglan design  
Polo collar neckline  
Regular fit  
Button fastening  
Superior Retail Fit :  
Men fitting from S to 3XL  
RRP : 59.90 MYR / 23.90 SGD



Size	S	M	L	XL	2XL	3XL
Width	48	51	53	56	58	60
Length	68	71	73	76	79	81

Measurements may vary +/- 5% from actual product  
Measurements are presented in cm



## SMW 1600 FADHILAH

100% Performance Dry Pique  
 Round neckline  
 Sporty raglan design  
 Waistline pocket feature  
 New asian A shape muslimah cutting  
 Soft and smooth handfeel  
 Antimicrobial, Anti-odor  
 Breathable performance  
 Woven Label  
 Superior Retail Fit : Ladies fitting from S to 3XL

Size	S	M	L	XL	2XL	3XL
Width	48	51	53	56	58	60
Length	89	91	94	96	99	101

Measurements may vary +/- 5% from actual product  
 Measurements are presented in cm



SMW 1601  
Navy  
Heliconia / White

SMW 1602  
Charcoal  
White / Black

SMW 1603  
Forest Green  
Daisy / Maroon

SARRA®



## SMW 1800 OBADIAH

### Muslimah Wear

100% Performance Dry Pique  
 Solid coloured muslimah top  
 Round neckline  
 Hidden side pocket  
 New asian A shape muslimah cutting  
 Lightweight material  
 Soft feel, breathable performance  
 Woven label  
 Superior Retail Fit : S -3XL  
 RRP : 49.90 MYR / 19.90 SGD



SMW 1801  
Heliconia

SMW 1802  
Irish Green

SMW 1803  
Purple



SMW 1804  
Black

SMW 1805  
Navy

Size	S	M	L	XL	2XL	3XL
Width	48	51	53	56	58	60
Length	89	91	94	96	99	101

Measurements may vary +/- 5% from actual product  
 Measurements are presented in cm



SARRA®



## Muslimah Wear SMW 1900 - MILES

Embracing the beauty of all women. Sarra is designed to accentuate the features of contemporary Muslim Women. We are very concerned about the conscience and modesty while featuring modern life, to offer you comfort and elegance.



100% Soft cotton denim  
 Pearlized buttons  
 Front button placket  
 Soft hand feel material  
 Light and comfortable  
 Regular collar completes the look  
 New asian A shape muslimah cutting  
 Great for both casual and dressier looks  
 Woven Label  
 Superior Retail Fit : S -3XL  
 RRP : 89.90 MYR / 36.90 SGD



SMW 1901  
Sky



SMW 1902  
Earl Blue



SMW 1903  
Midnight

Size	S	M	L	XL	2XL	3XL
Width	48	51	53	56	58	60
Length	89	91	94	96	99	101

Measurements may vary +/- 5% from actual product  
 Measurements are presented in cm



NORTH HARBOUR



## NHC 1100 Baseball Cap

Acrylic Twill  
6-panel Fitted Cap  
Seamed Front Panel with Full Buckram  
6 Sewn Eyelets  
Pro Stitch on Crown  
6 Rows of Stitching on Visor  
Matching Fabric Undervisor  
Matching Color Sweatband  
Metal Sliding Buckle Closure  
RRP : 26.90 MYR / 10.90 SGD



### 12 colors

- |                                                                                                               |                                                                                                                   |                                                                                                               |
|---------------------------------------------------------------------------------------------------------------|-------------------------------------------------------------------------------------------------------------------|---------------------------------------------------------------------------------------------------------------|
| <br>NHC 1101<br>White    | <br>NHC 1102<br>Grey         | <br>NHC 1103<br>Black    |
| <br>NHC 1104<br>Daisy    | <br>NHC 1105<br>Forest Green | <br>NHC 1106<br>Red      |
| <br>NHC 1107<br>Maroon   | <br>NHC 1108<br>Royal        | <br>NHC 1109<br>Navy     |
| <br>NHC 1110<br>Charcoal | <br>NHC 1111<br>Orange       | <br>NHC 1112<br>Sapphire |





## KIND OF COOL TREND

Acrylic Twill  
 6-panel Fitted Cap  
 Seamed Front Panel with Full Buckram  
 6 Sewn Eyelets  
 Pro Stitch on Crown  
 6 Rows of Stitching on Visor  
 Matching Fabric Undervisor  
 Matching Color Sweatband  
 Adjustable Snap Closure  
 RRP : 29.90 MYR / 11.90 SGD



NORTH HARBOUR

### NHC 1200 SNAPBACK

-   
 NHC 1201  
 White
-   
 NHC 1202  
 Grey
-   
 NHC 1204  
 Forest Green
-   
 NHC 1205  
 Red
-   
 NHC 1206  
 Royal
-   
 NHC 1207  
 Navy
-   
 NHC 1203  
 Black



NORTH HARBOUR



- NHT 1101  
Soft White
- NHT 1102  
Corn Silk
- NHT 1103  
Mint Cream
- NHT 1104  
Dust Blue
- NHT 1105  
Watermelon



## NHT 1100 Soft Touch Hand Towel



Material: 100% Cotton  
Weight: 80 gsm  
Soft Touch hand feel  
Ideal for a wide variety of uses  
Striped border offers a touch of appeal  
Exceptionally plush, rich and long lasting  
Cozy comfort, durable and highly absorbent  
Simplicity and elegance  
Available in 5 colors.  
Easy care, machine washable  
Satin label  
Size: 32cm x 70cm  
RRP : 29.90 MYR / 11.90 SGD



NORTH HARBOUR



## NHT 2100 Soft Touch Spa Towel

Material: 100% Cotton  
Weight: 400 gsm  
Soft Touch hand feel  
Ideal for washroom ensemble  
Striped border offers a touch of appeal  
Exceptionally plush, rich and long lasting  
Cozy comfort, durable and highly absorbent  
Simplicity and elegance  
Available in 5 colors  
Easy care, machine washable  
Satin label  
Size: 70cm x 140cm  
RRP : 49.90 MYR / 19.90 SGD

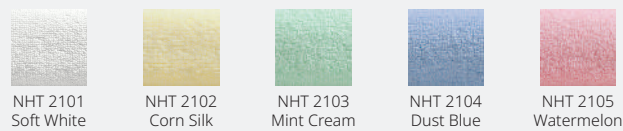





**LOFTEX**

---

## MONTEX Anti-bacterial Towel

---

100% high-quality cotton  
Impressive absorbency rate  
Quick-dry characteristic  
Prevent odour  
Hand or machine washed  
Tumble dried in low heat  
Hypoallergenic towel.

**BATH TOWEL (BT)**  
68 cm x 137 cm  
weight : 420 gram  
RRP : 69.90 MYR / 27.90 SGD

**HAND TOWEL (HT)**  
35 cm x 76 cm  
weight : 100 gram  
RRP : 39.90 MYR / 16.90 SGD

**FACE TOWEL (FT)**  
33 cm x 33 cm  
weight : 50 gram  
RRP : 29.90 MYR / 11.90 SGD



268  
Berry

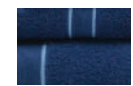

765  
Icelandic Blue

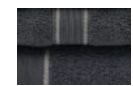

042  
Steel Grey



105  
Fungi Brown



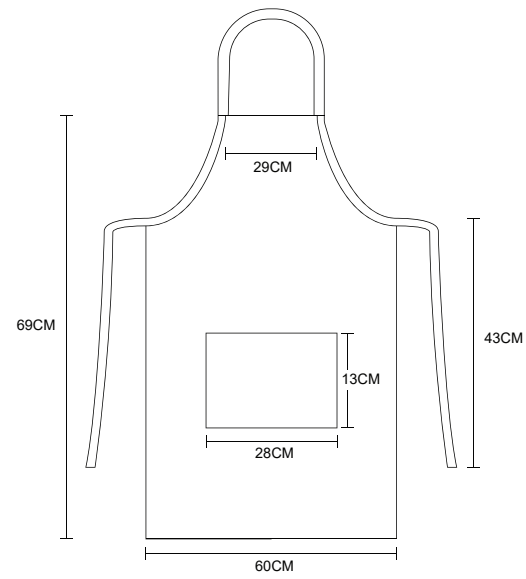







NORTH HARBOUR

## NHA 1100 VICIOUS APRON

Material : 100% Polyester  
 With practical pockets for small items  
 The loop makes it easy to hang  
 Strong seams for extra durability  
 Simplicity and elegance  
 High-grade materials & excellent workmanship  
 soft in texture and has no smell  
 Available in 6 colors.  
 Easy care, machine washable  
 Satin Label  
 Size : 60cm x 69cm  
 RRP : 29.90 MYR / 9.90 SGD



### 6 colors

- |                                                                                                         |                                                                                                         |                                                                                                                |
|---------------------------------------------------------------------------------------------------------|---------------------------------------------------------------------------------------------------------|----------------------------------------------------------------------------------------------------------------|
|  NHA 1101<br>Black |  NHA 1102<br>Navy  |  NHA 1105<br>Forest Green |
|  NHA 1103<br>Red   |  NHA 1104<br>Royal |  NHA 1106<br>Khaki        |





## CRM 1100 Premium Eco Face Mask

Performance Flat Knit  
Breathable lightweight material  
Adjustable elastic ear loop  
With filter pocket  
Comfortable fit and shape contours to face  
Eco-friendly and sustainable masks  
Soft yet durable construction  
Washable and reusable  
Protection for daily use  
Available in adult and youth sizes  
RRP : 29.90 MYR / 9.90 SGD

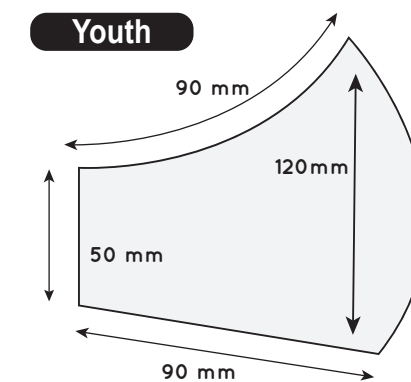
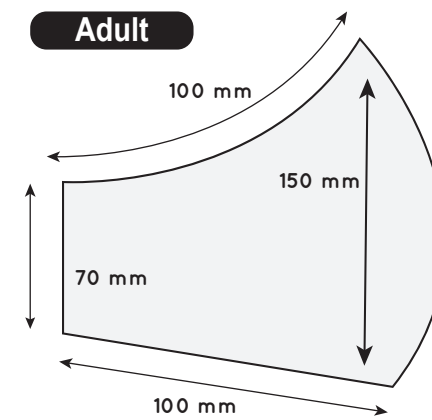





## CRM 1200 Eco Designer Mask

Sandwich Fabric, Air Mesh  
 Sublimated face mask  
 Breathable lightweight material  
 Adjustable elastic ear loop  
 With filter pocket  
 Comfortable fit and shape contours to face  
 Eco-friendly and sustainable masks  
 Soft yet durable construction  
 Washable and reusable  
 Protection for daily use  
 Available in adult and youth sizes  
 RRP : 39.90 MYR / 10.90 SGD

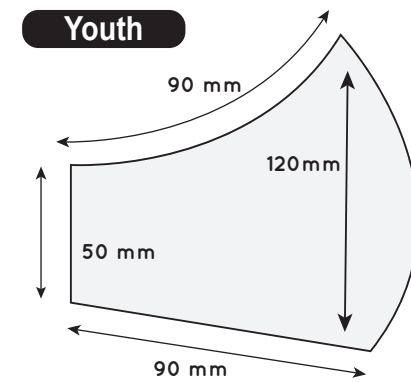
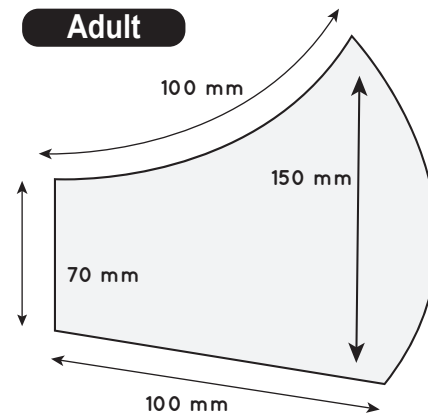

CRM 1201



CRM 1202



CRM 1203



CRM 1204



CRM 1205



CRM 1206



CRM 1207



CRM 1208



CRM 1209



CRM 1210

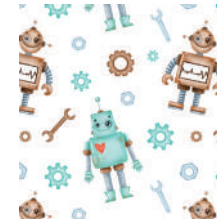

CRM 1211



CRM 1212

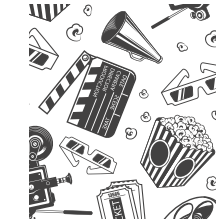

CRM 1213



CRM 1214



CRM 1215

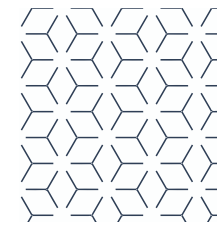

CRM 1216

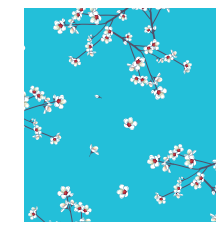

CRM 1217



CRM 1218



CRM 1219

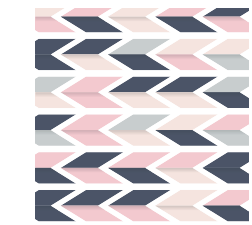

CRM 1220



CRM 1221



CRM 1222

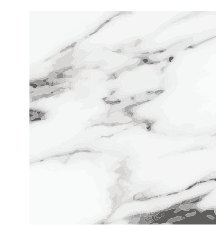

CRM 1223



CRM 1224

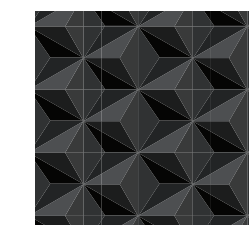

CRM 1225



CRM 1226



CRM 1227



CRM 1228

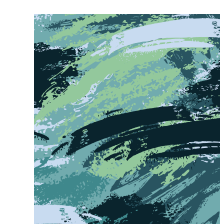

CRM 1229

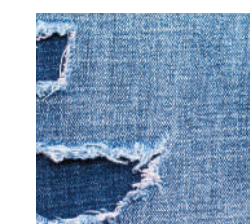

CRM 1230



## Decorating Techniques

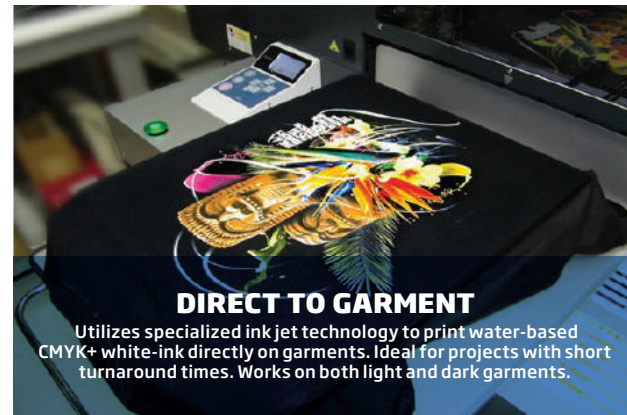

### DIRECT TO GARMENT

Utilizes specialized ink jet technology to print water-based CMYK+ white-ink directly on garments. Ideal for projects with short turnaround times. Works on both light and dark garments.

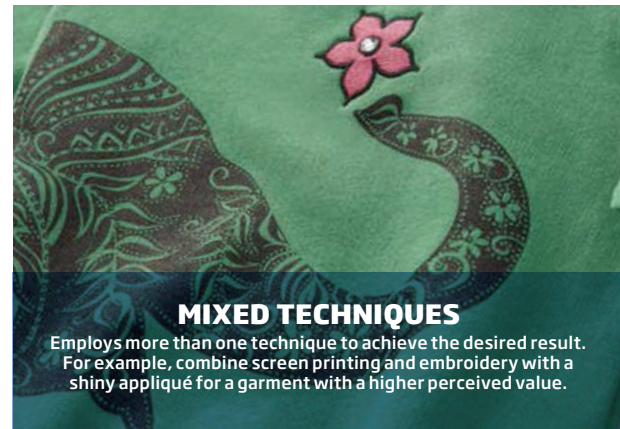

### MIXED TECHNIQUES

Employs more than one technique to achieve the desired result. For example, combine screen printing and embroidery with a shiny appliqué for a garment with a higher perceived value.



### DISCHARGE PRINTING

This form of screen printing prevents color mixing. It uses a waterbased catalyzed ink with an added activator which first removes color in the garment before adding the new color.



### EMBROIDERY

Embroidery is sewing a design, type or logo onto a garment with special thread. It gives garments a higher perceived value and works very well on fleece and heavier weight garments.

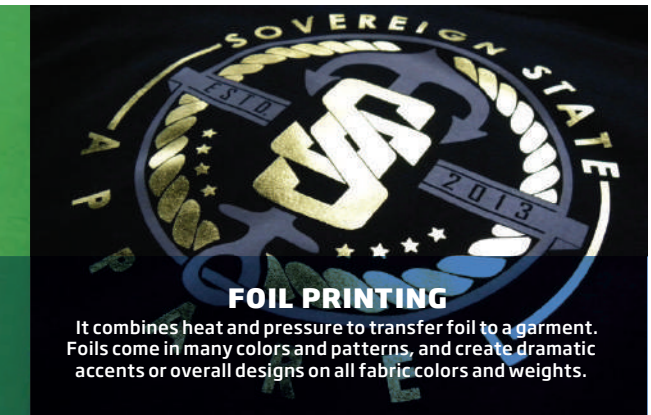

### FOIL PRINTING

It combines heat and pressure to transfer foil to a garment. Foils come in many colors and patterns, and create dramatic accents or overall designs on all fabric colors and weights.

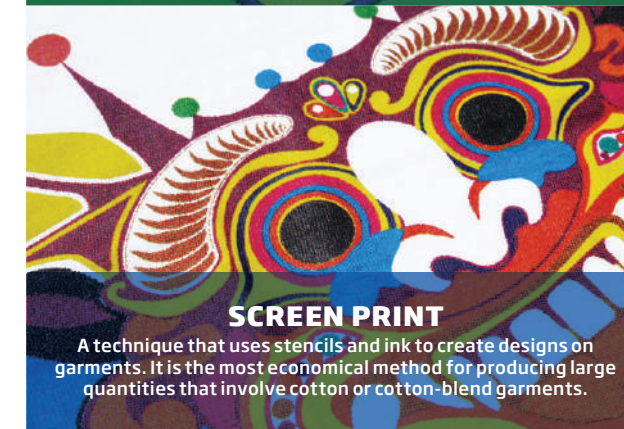

### SCREEN PRINT

A technique that uses stencils and ink to create designs on garments. It is the most economical method for producing large quantities that involve cotton or cotton-blend garments.



### SUBLIMATION

This process utilizes heat-sensitive inks to create long-lasting, full-color, photo-quality reproductions of digital images. Sublimation is well suited for 100% polyester garments.



### HOT SPLIT TRANSFER PRINTING

Combines heat and pressure to transfer images to garments. Most of the ink melts into the fabric to create a softer, lighter feeling print. Great for customization and shorter runs.



### HEAT TRANSFER

Heat transfer involves combining heat and pressure to transfer images to garments. This is a great option for detailed prints, customization, shorter runs and quick turnaround times.

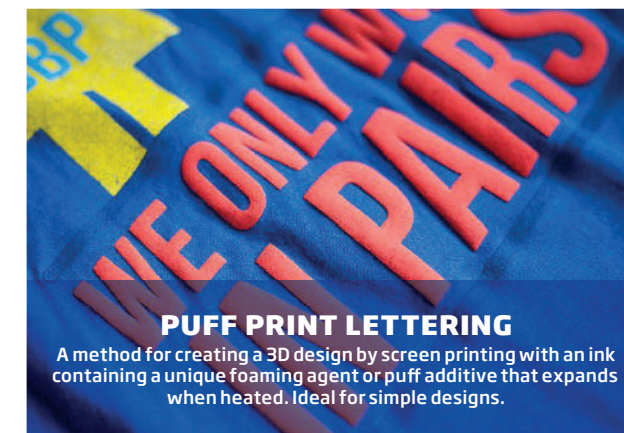

### PUFF PRINT LETTERING

A method for creating a 3D design by screen printing with an ink containing a unique foaming agent or puff additive that expands when heated. Ideal for simple designs.



### GLITTER PRINTING

A special clear glitter topcoat is screen printed on top of the colored design to add shine and impact to your design. This technique can work on all colors and weights of fabrics.



### REFLECTIVE PRINTING

Small glass beads in the carrier base of reflective inks cause any bright light to reflect off the print. This technique works best on larger print areas with simple designs.

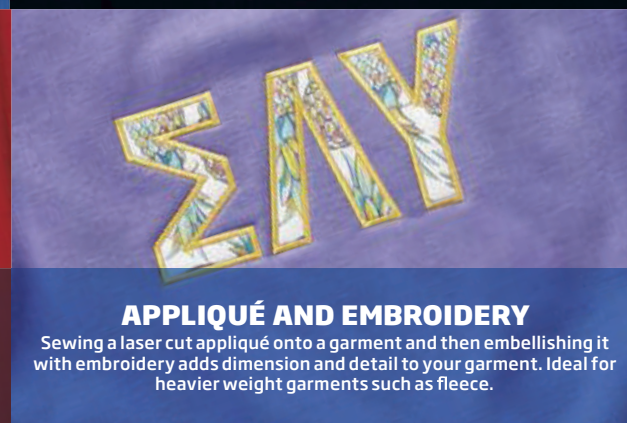

### APPLIQUÉ AND EMBROIDERY

Sewing a laser cut appliqué onto a garment and then embellishing it with embroidery adds dimension and detail to your garment. Ideal for heavier weight garments such as fleece.



### DISTRESSED AND CLEAR INK

Distressed printing gives screen prints an intentionally weathered look. Clear inks can be used to add a glossy shine or dimension to a design.

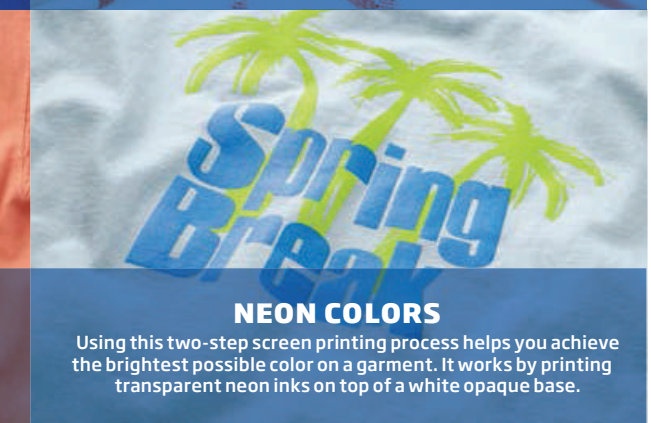

### NEON COLORS

Using this two-step screen printing process helps you achieve the brightest possible color on a garment. It works by printing transparent neon inks on top of a white opaque base.



## POLOS

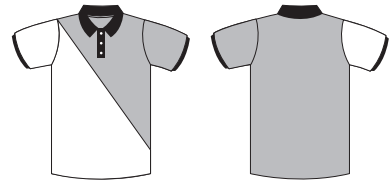

NHB 2100 - Georgia Polo

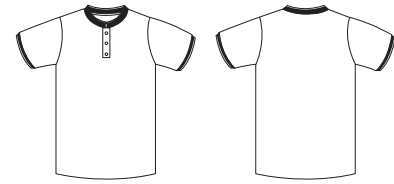

NHB 2200 - York Polo

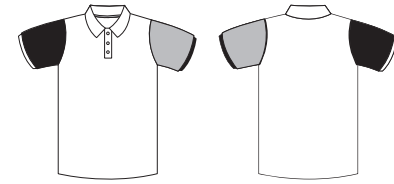

NHB 2300 - Murphy Polo

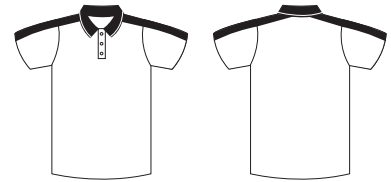

NHB 2500 - Muller Polo

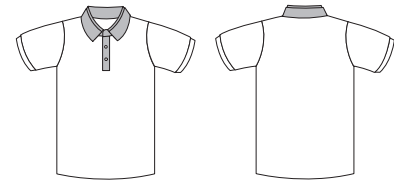

NHB 2800 - Glance Polo

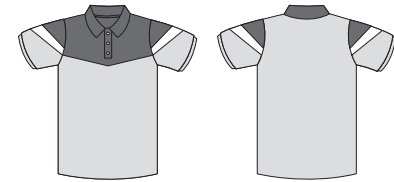

NHB 2900 - Adley Polo

## PREMIUM WORKWEAR

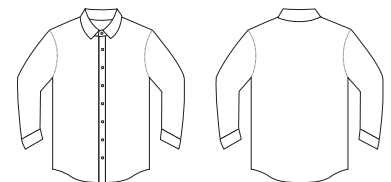

NHB 1400 - Premium Oxford

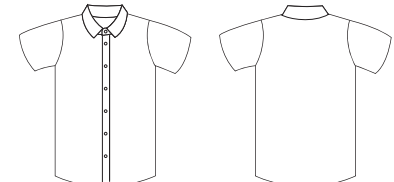

NHB 1500 - Oxford Short Sleeve

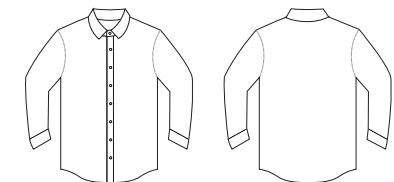

NHB 2000 - Cotton Rayon Shirt

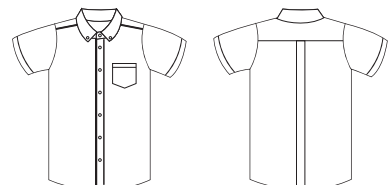

NHB 1700 - Synergy Racewear

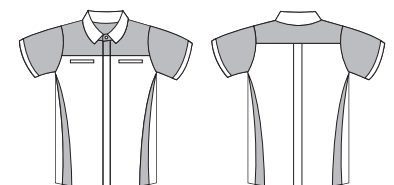

NHB 1800 - Impact Racewear

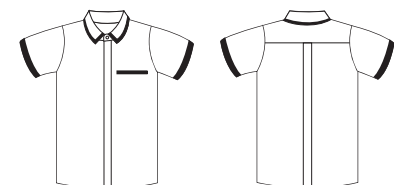

NHB 1900 - Smart Racewear

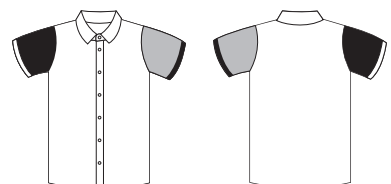

NHB 2600 - Murphy Racewear

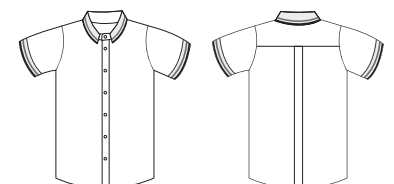

NHB 3000 - Cyril Shirt

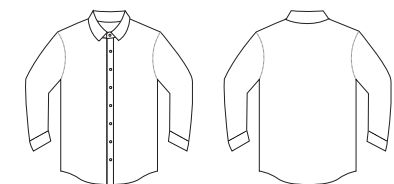

NHB 3100 - Virgil Shirt

## ACTIVEWEAR

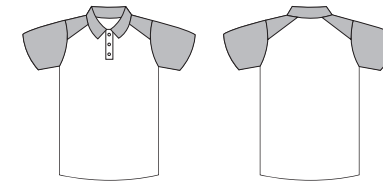

CRP 2100 - Infinite Polo

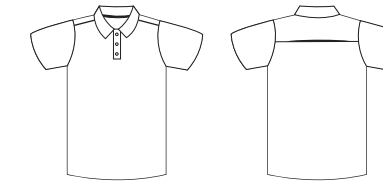

CRP 2300 - Oxley Polo

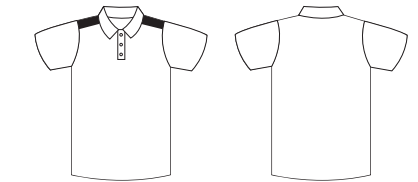

CRP 2400 - Henderson Polo

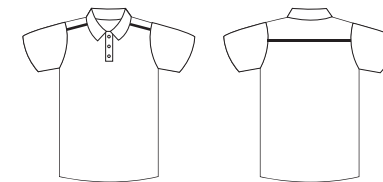

CRP 2500 - Ocean Polo

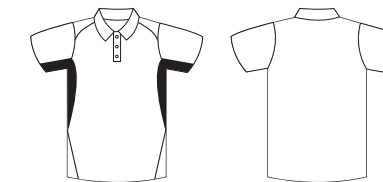

CRP 1300 - Delta Polo

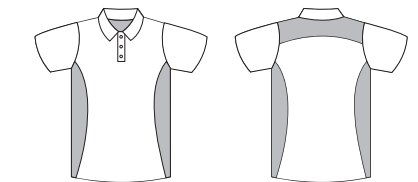

CRP 1400 - Explorer Polo

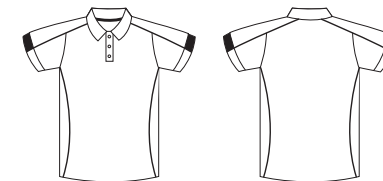

CRP 1500 - Finisher Polo

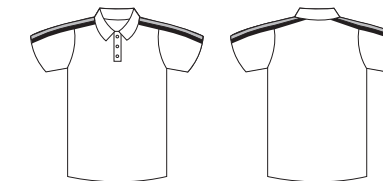

CRP 1600 - Racer Polo

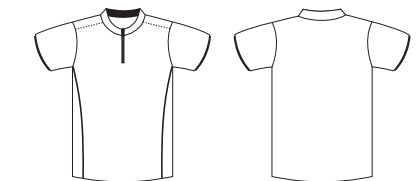

CRP 2900 - Paragon Polo

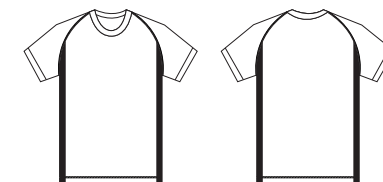

CRR 1100 - Storm Tee

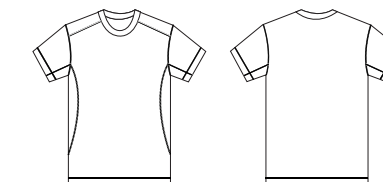

CRR 1200 - Velocity Tee



CRR 1300 - Zen Tee



CRV 1600 - Flex Running Vest



CRT 1200 J - Neil Track Jacket

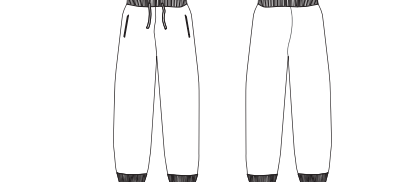

CRT 1100 P - Zeal Active Trackpants

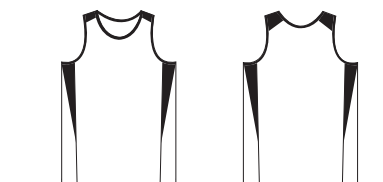

CRB 1100 - Vanguard Basketball Suit (Tops & Bottoms)

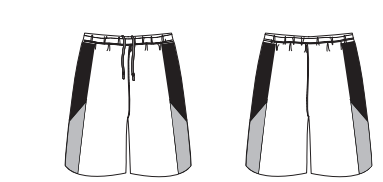



Min-i-mal-ism  
the ability to simplify without  
losing any quality







Sublimation by Crossrunner.

ラクだけどしっかりおしゃれ。

Collection 2022-2023

# BUYER'S GUIDE

GILDAN CROSSRUNNER<sup>®</sup> NORTH FACE<sup>®</sup> STATESIDE  
ANVIL<sup>®</sup> COMFORT COLORS<sup>®</sup> American Apparel SARRA

Impact, Influence and Inspiration | Iconic and Essential Garments.



6 074558 24000 0